

Animation

Challenge Cards



Animation

Challenge Cards



Animation

Challenge Cards



Animation

Challenge Cards



Can you create your own design for a new cartoon flip book?



Can you write a set of instructions on how to make a thaumatrope?



Can you remember what a stereoscope is?
Could you draw or describe how it works?

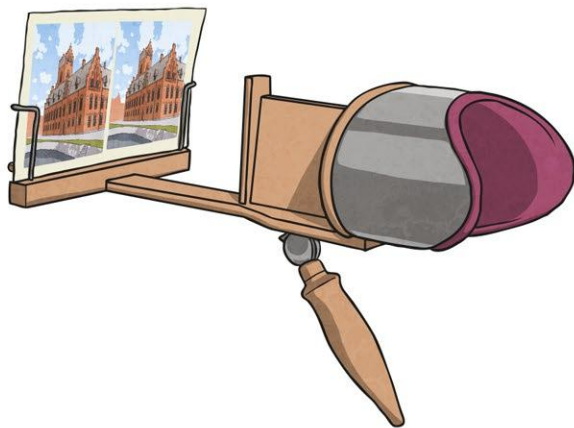

Can you remember what a zoetrope is?
Could you draw or describe how it works?



Write a beginner's guide to the software you have been using.



Use Pivot Animator to make an animated stick figure that spells the letters of your name.

Find out about a famous animator such as Walt Disney, Hanna and Barbera or Nick Park.

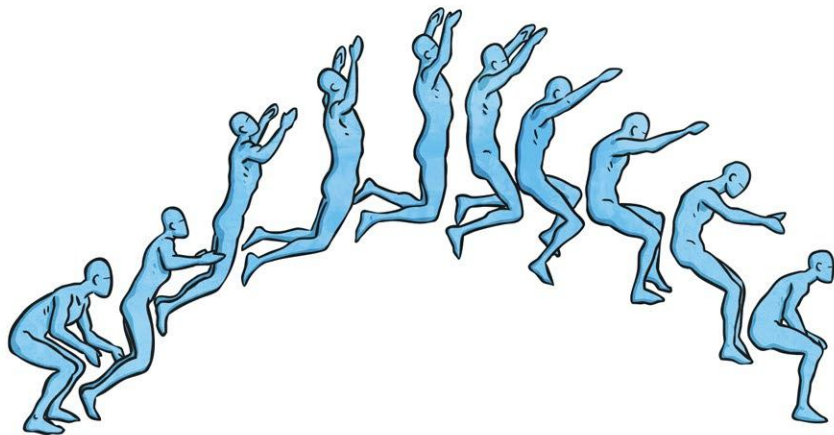

Research Pixar and see how many animated Pixar films you can find and recognise.

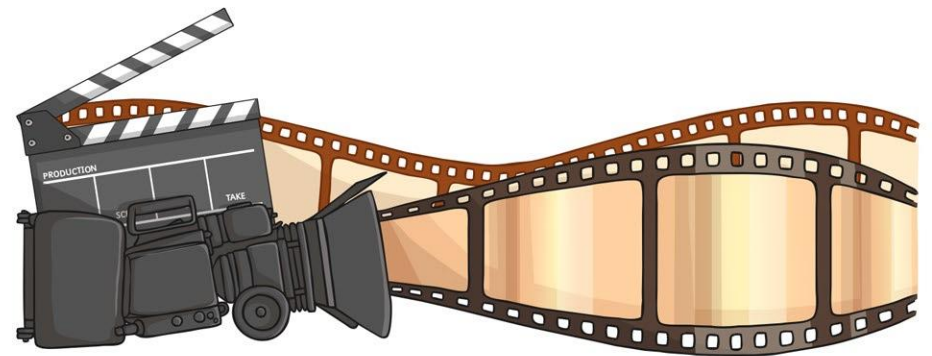

Use your knowledge to create a quiz based on either animation or animated movies. Write 10 questions and answers.

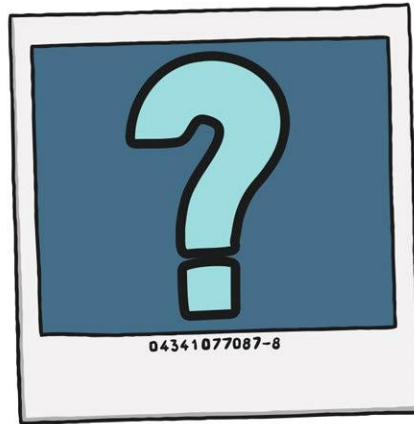

Use MovieSoup to animate a scene where one sea creature is chased by another.



Write an A-Z of animation.

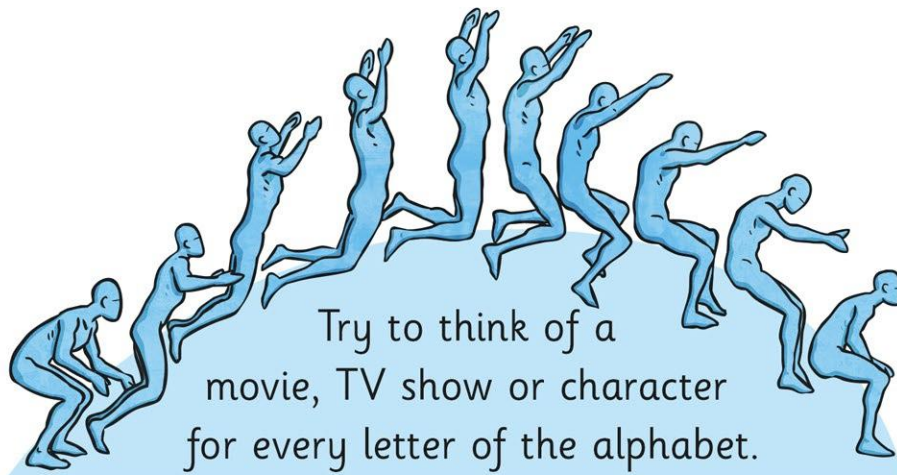



innout





imati



ion







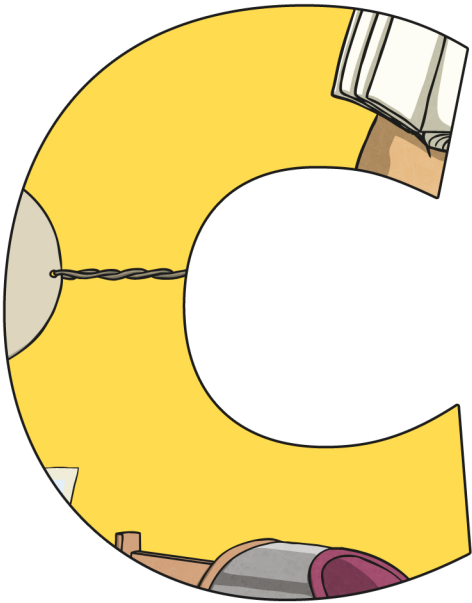
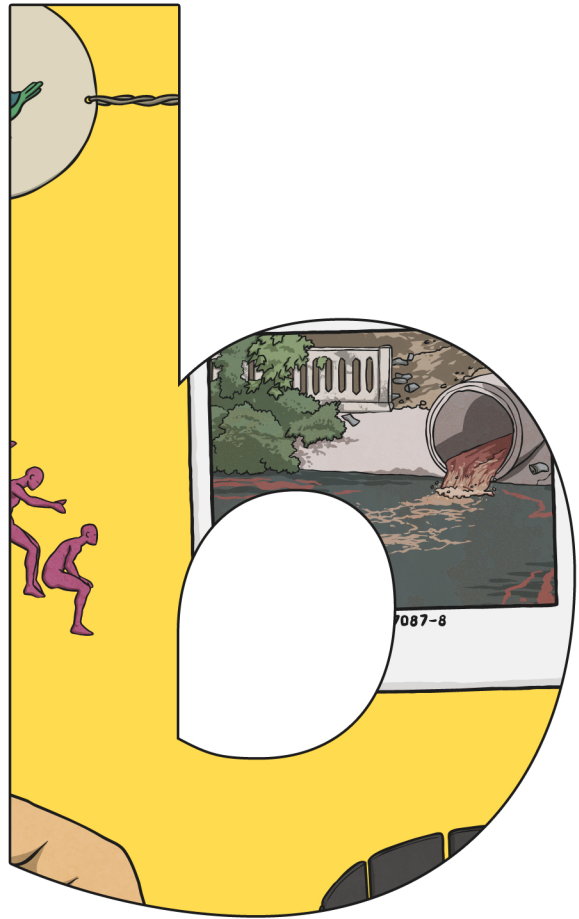

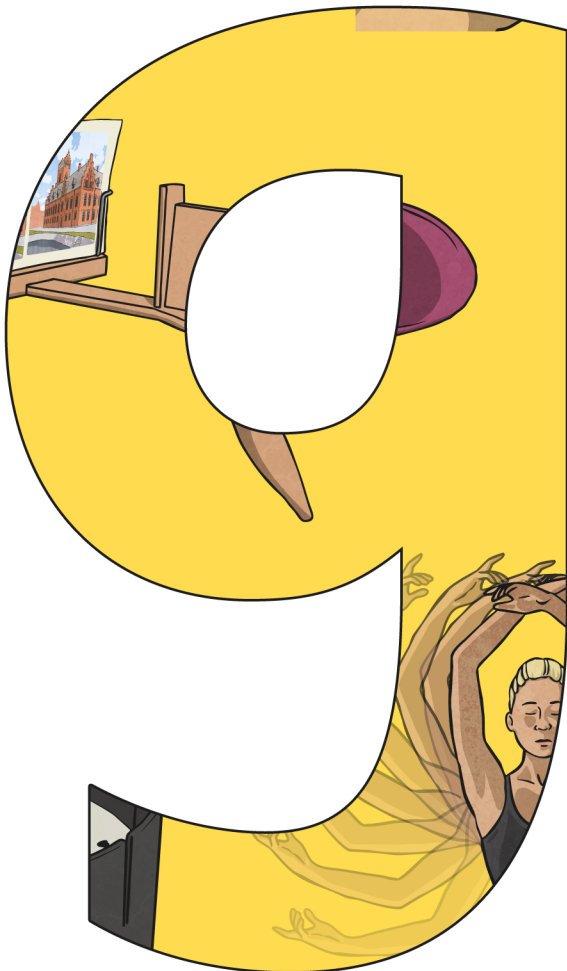
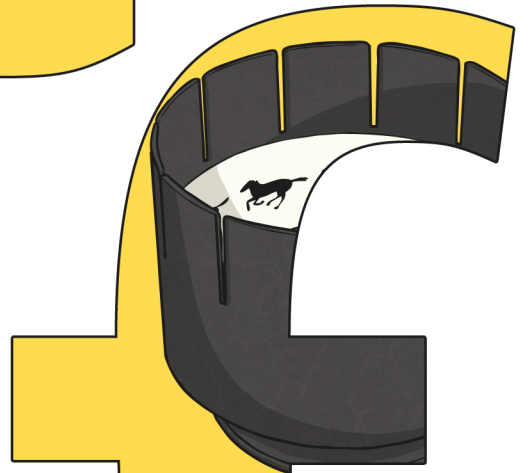
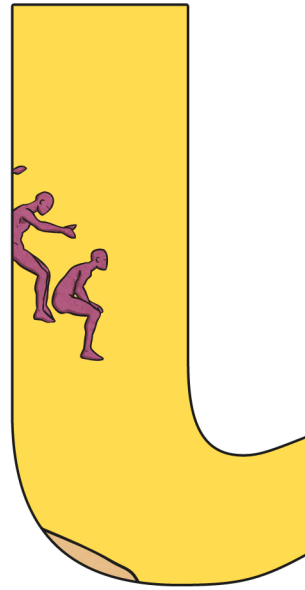
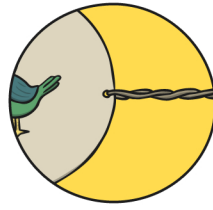

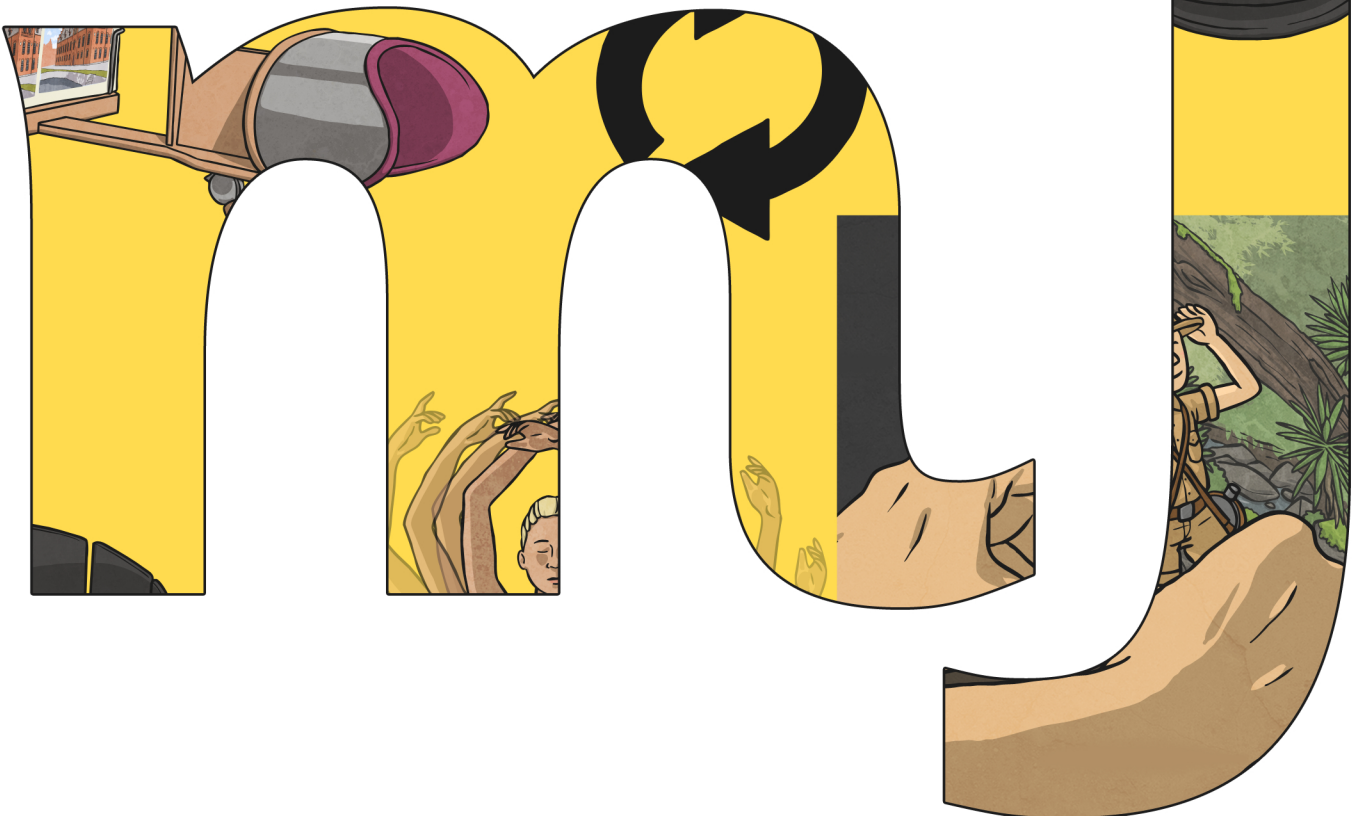
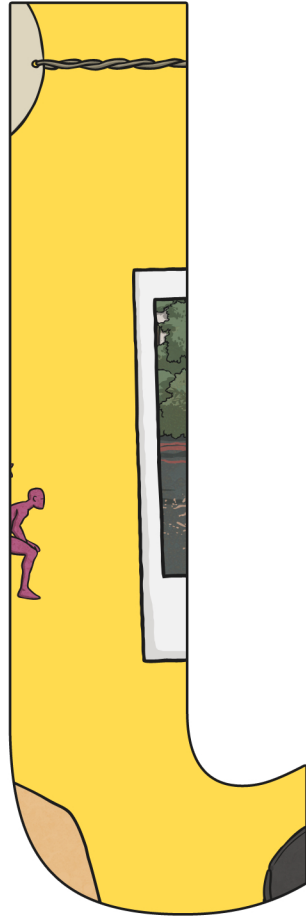
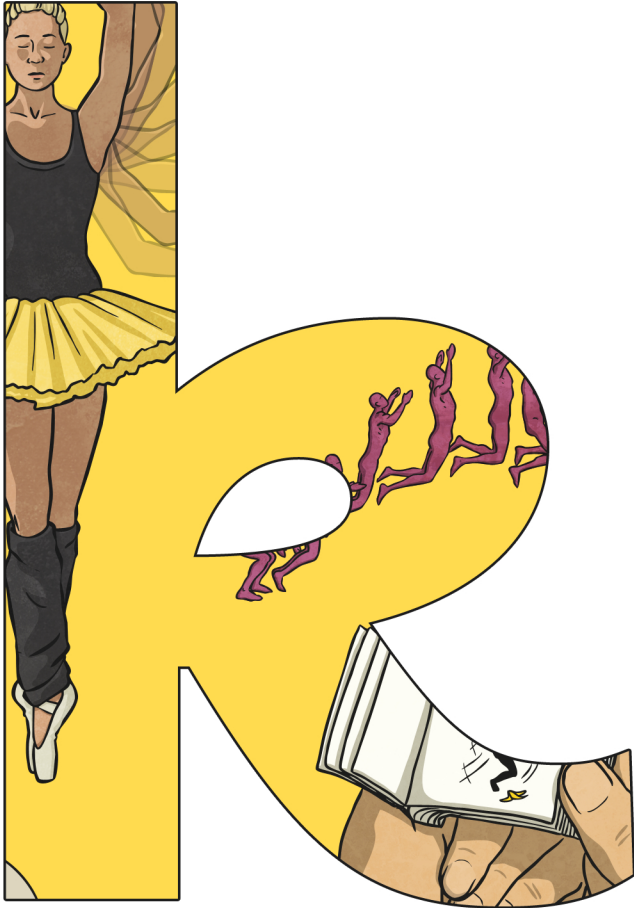

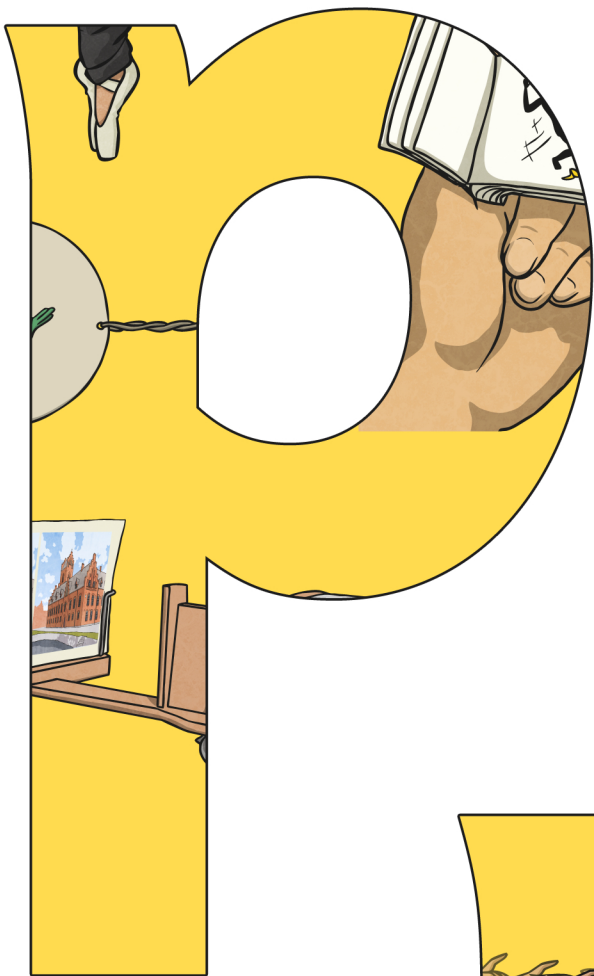

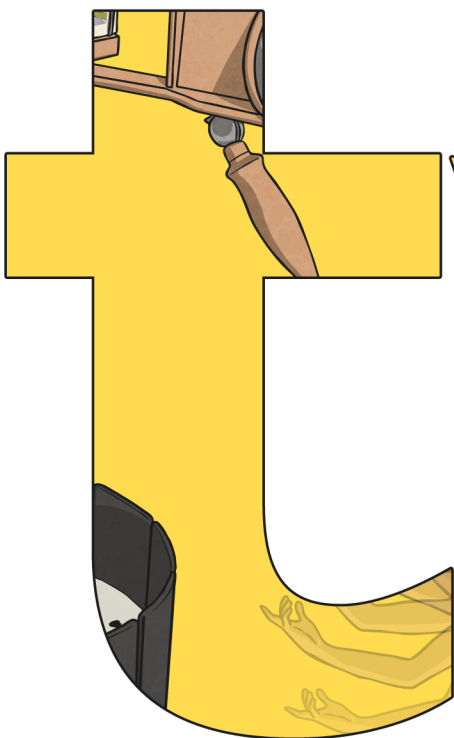
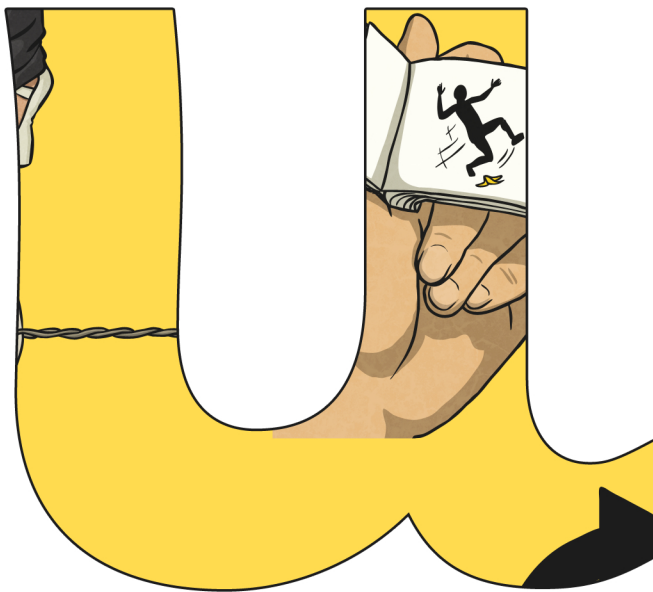

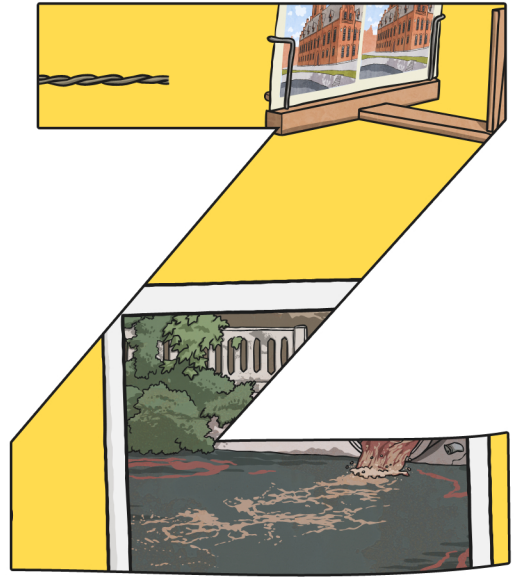
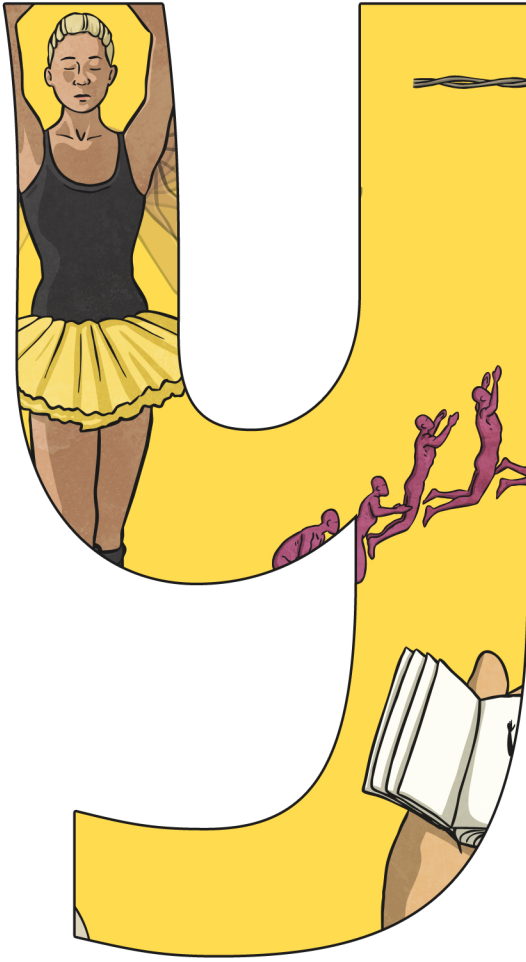

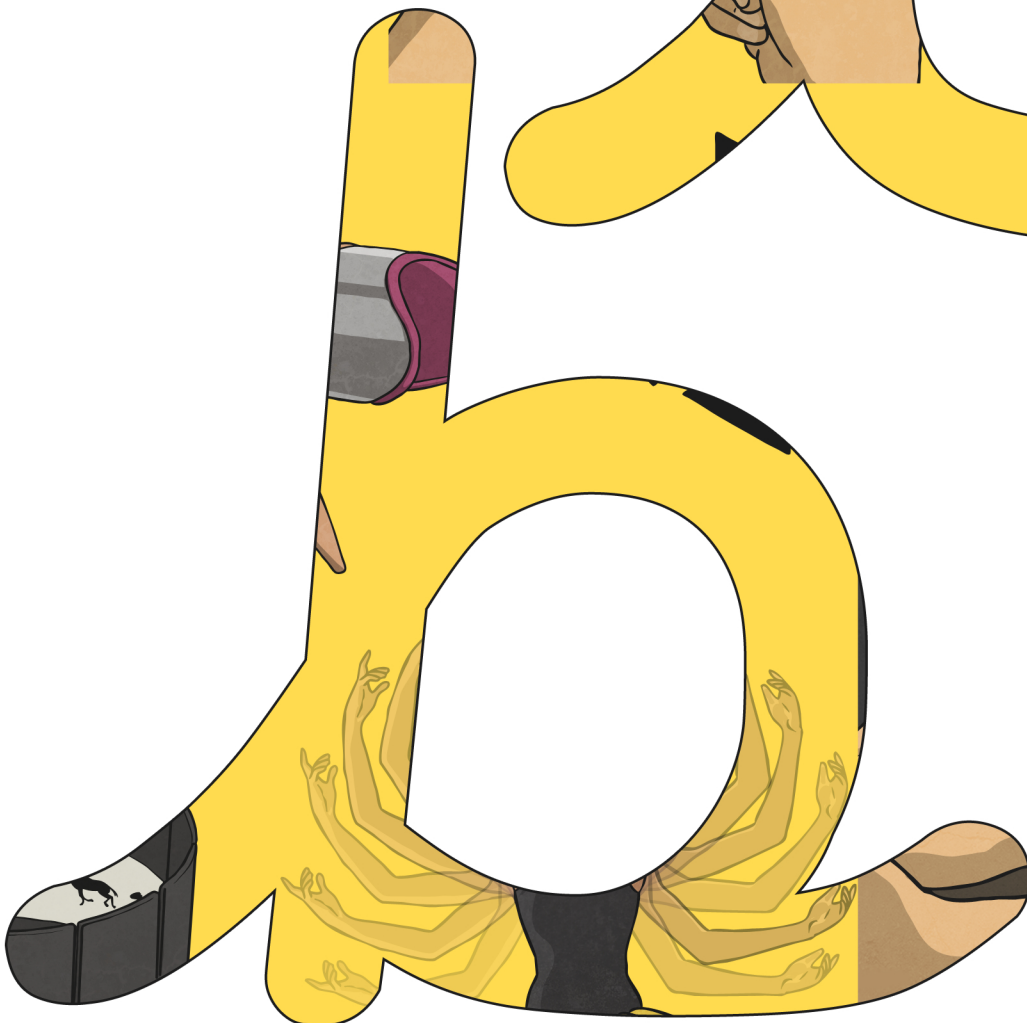
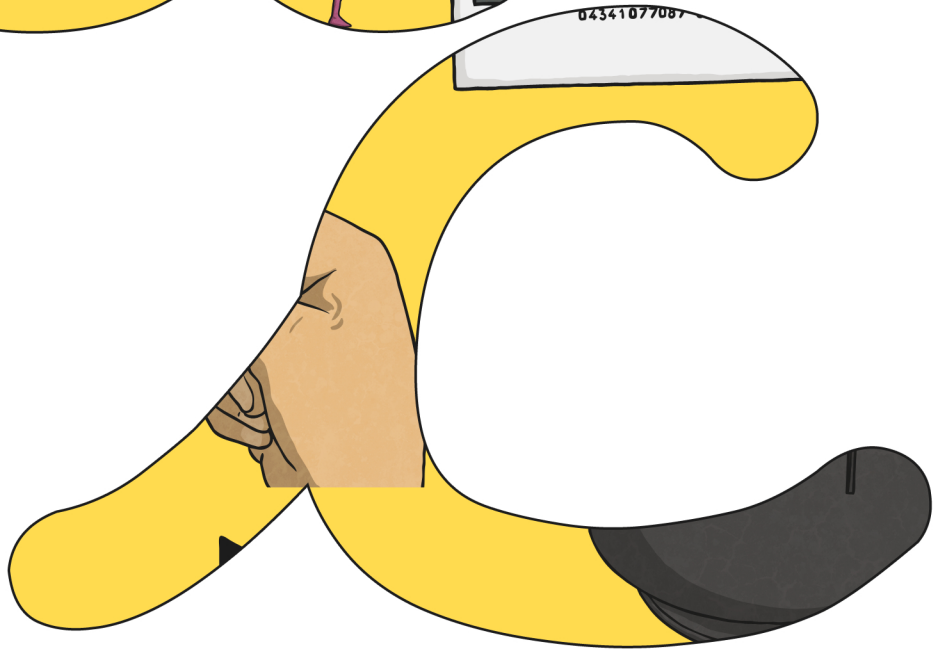
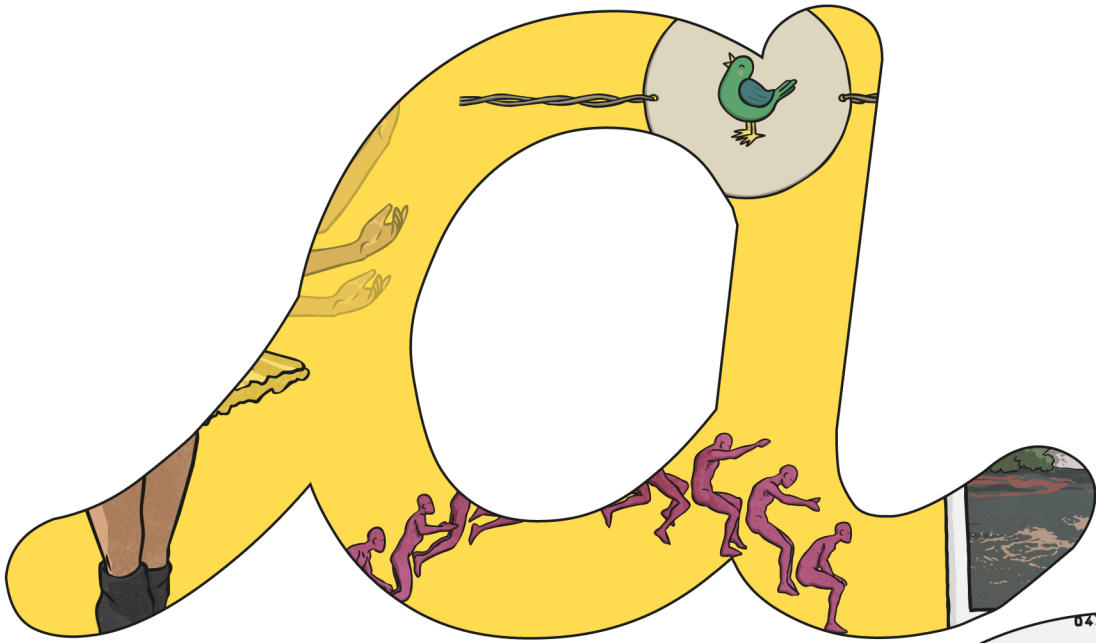

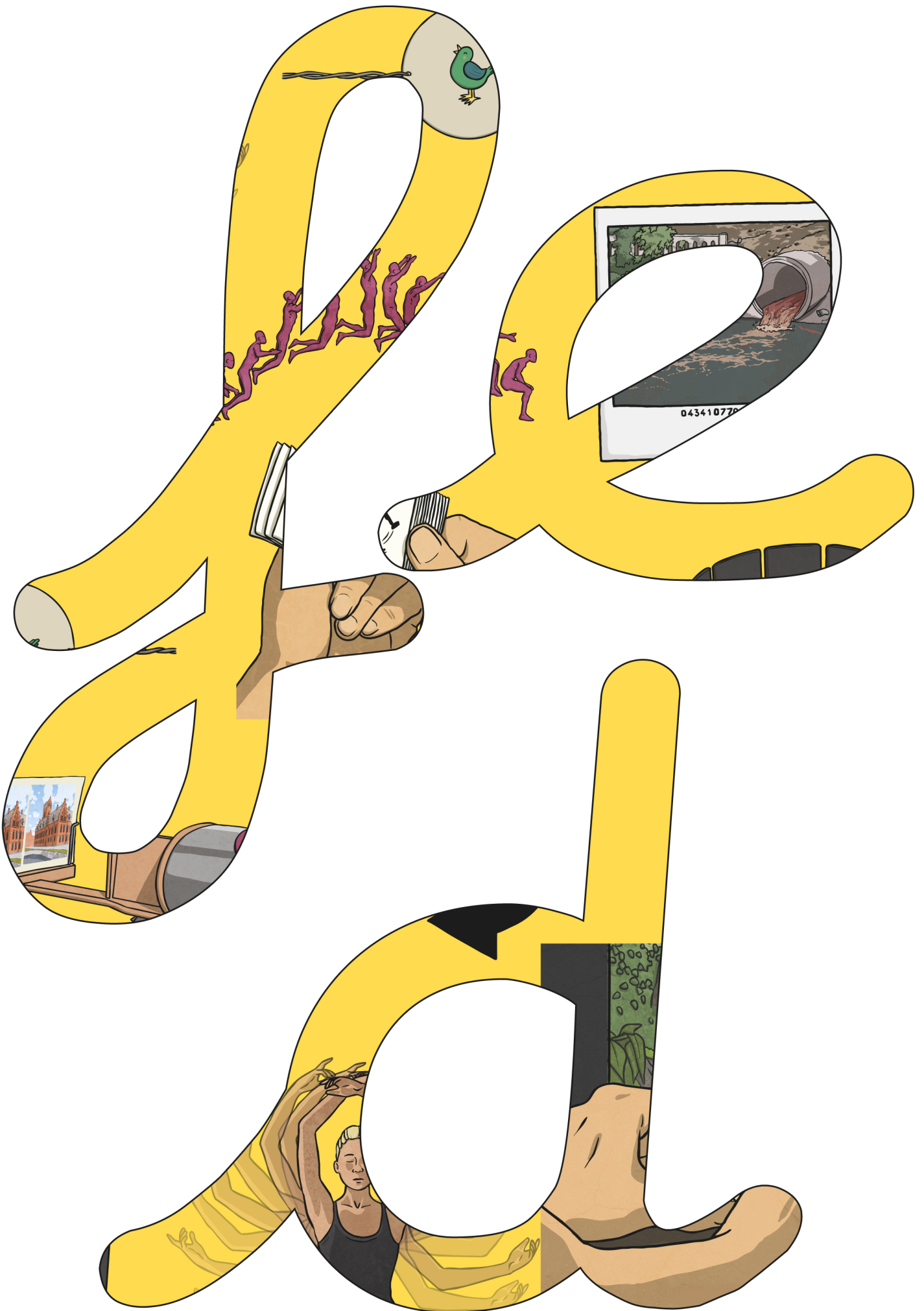

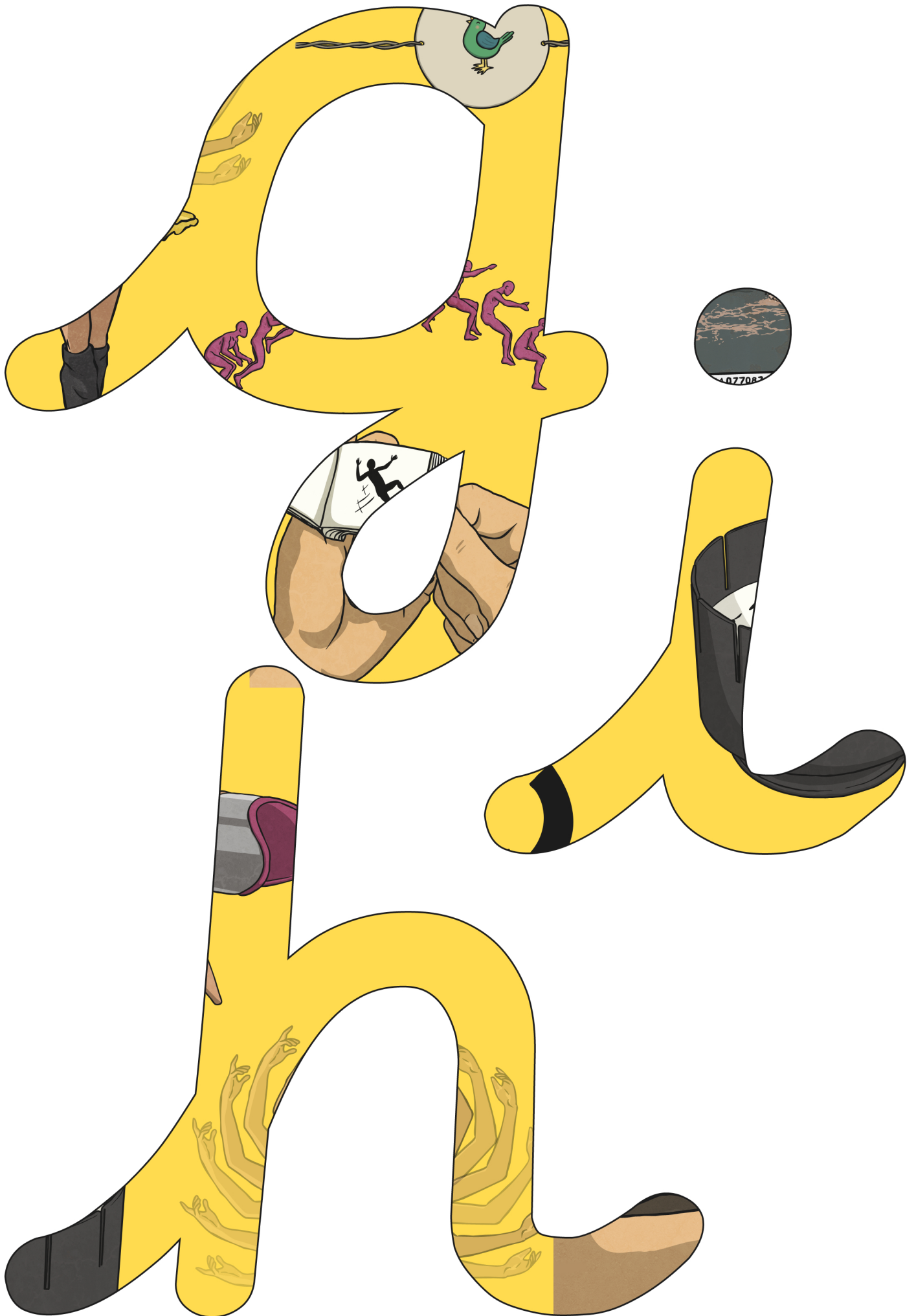



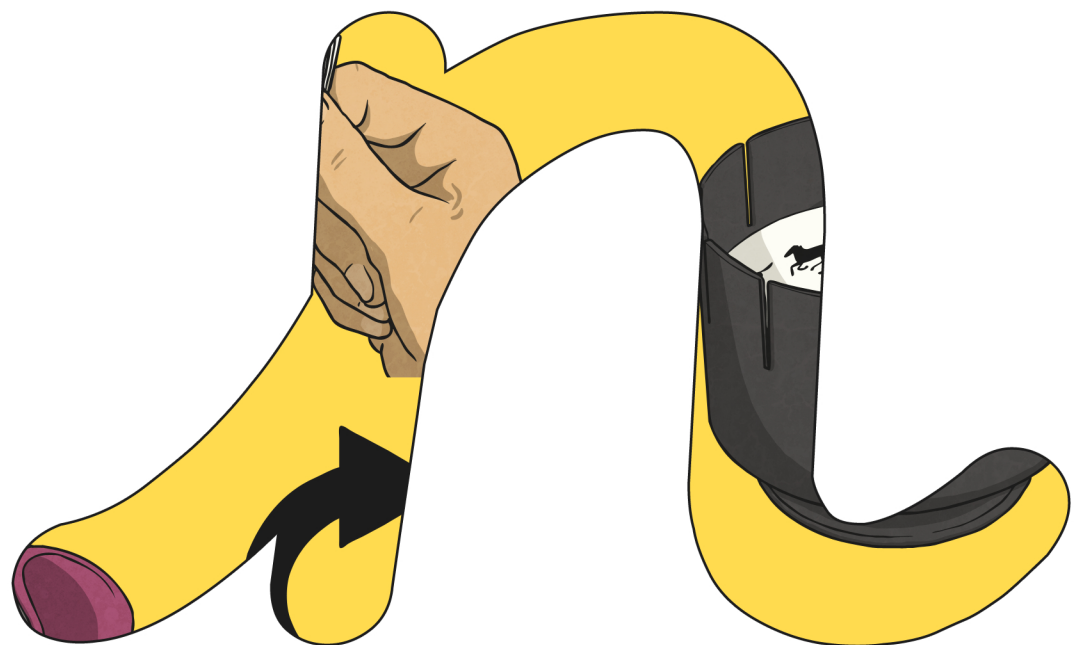
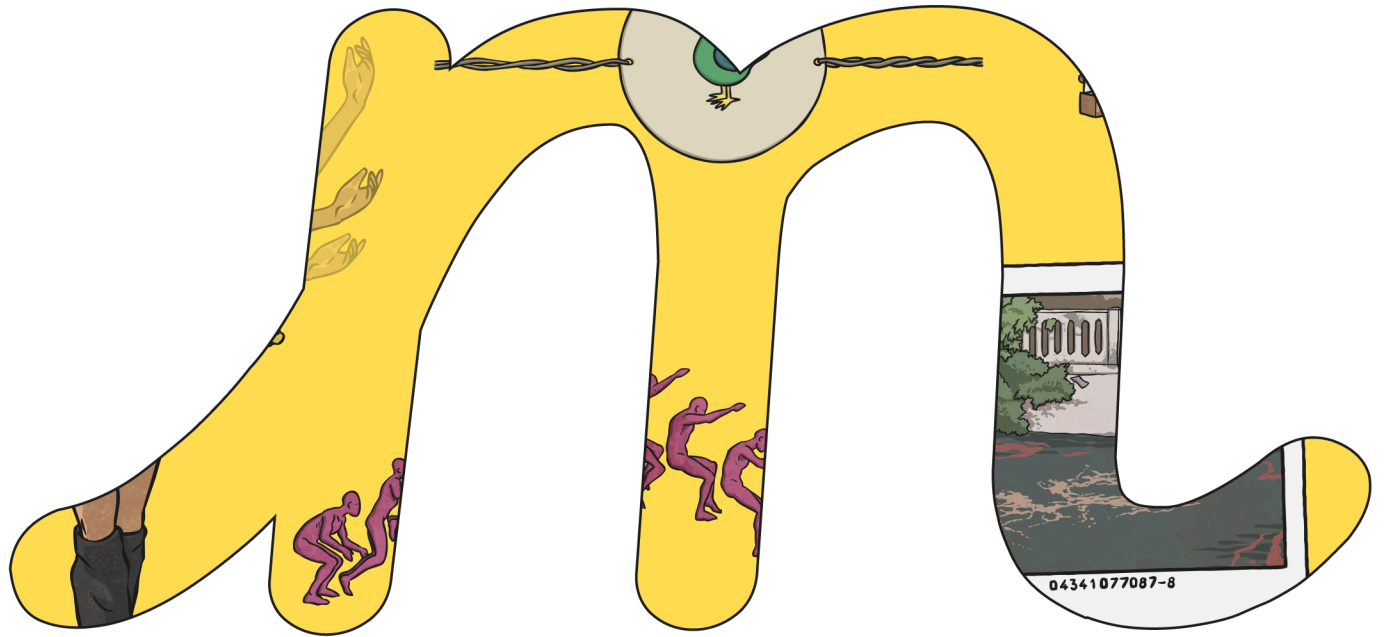



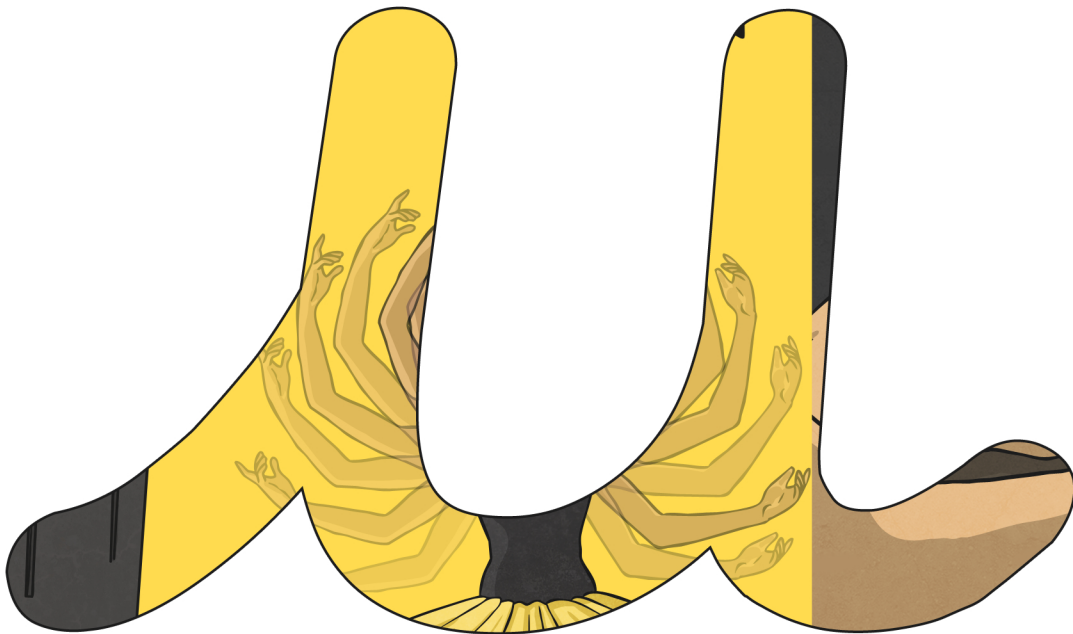
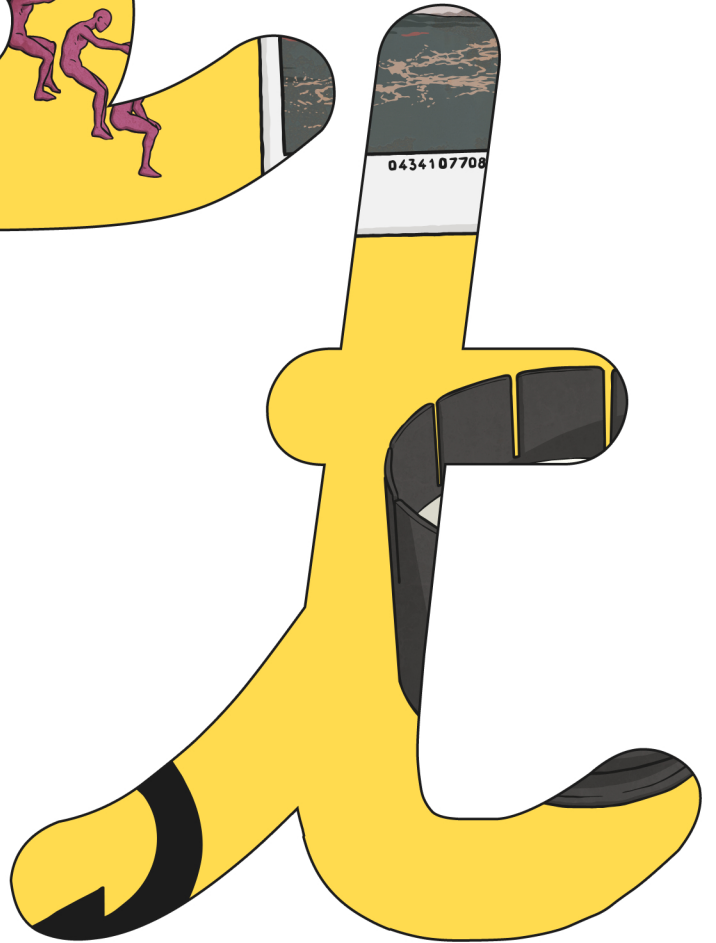
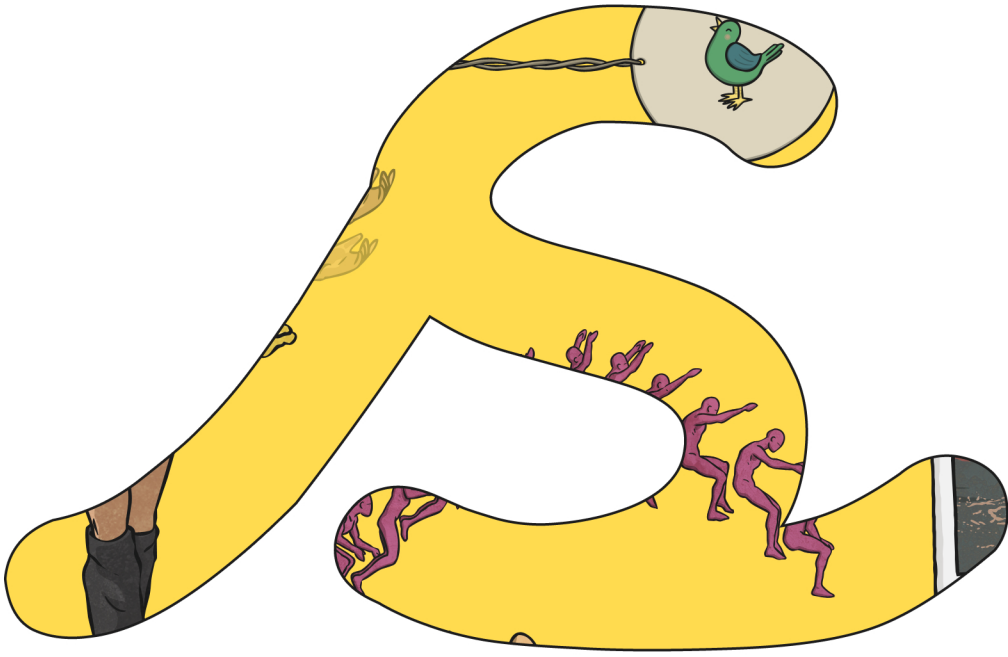

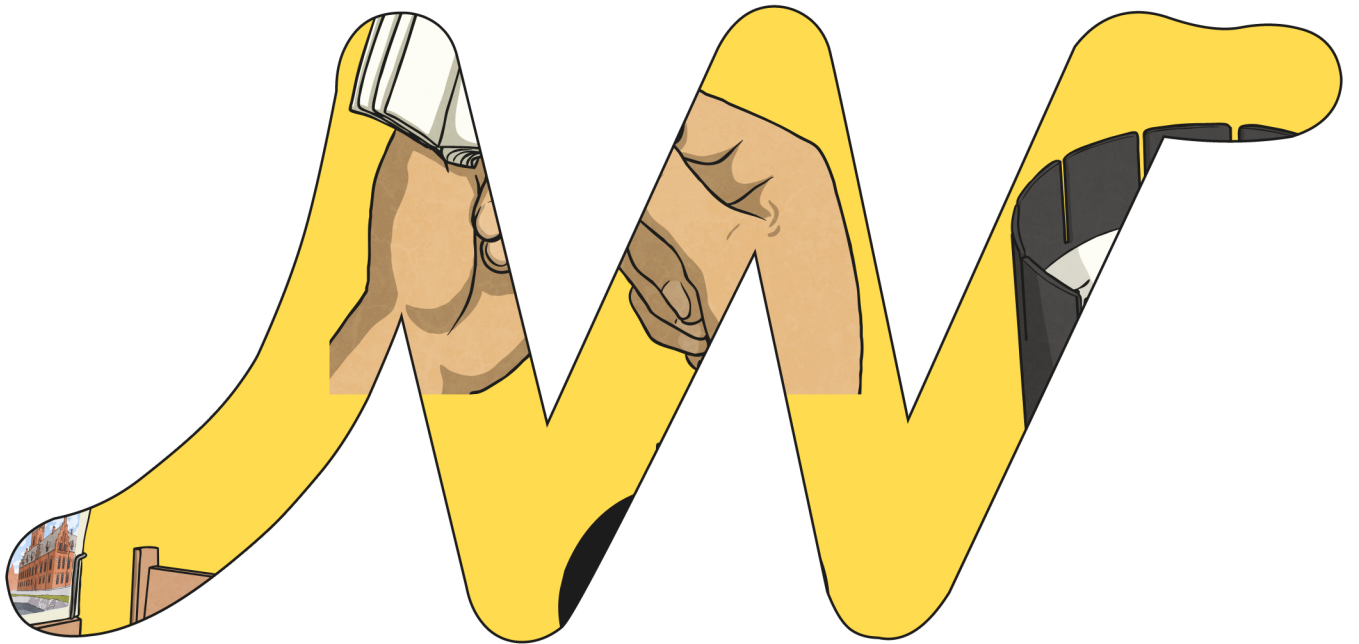
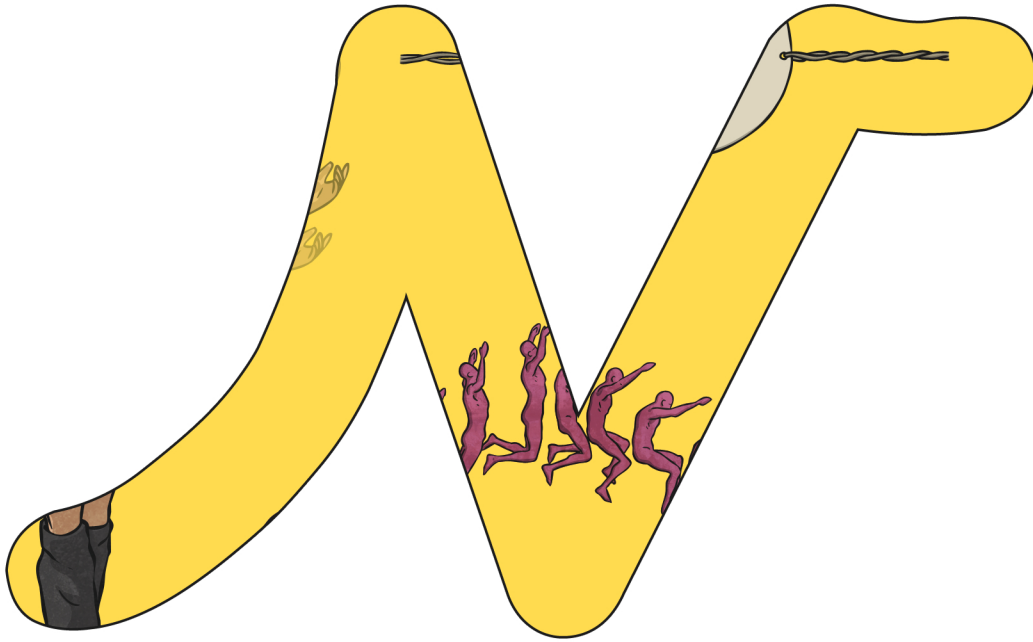

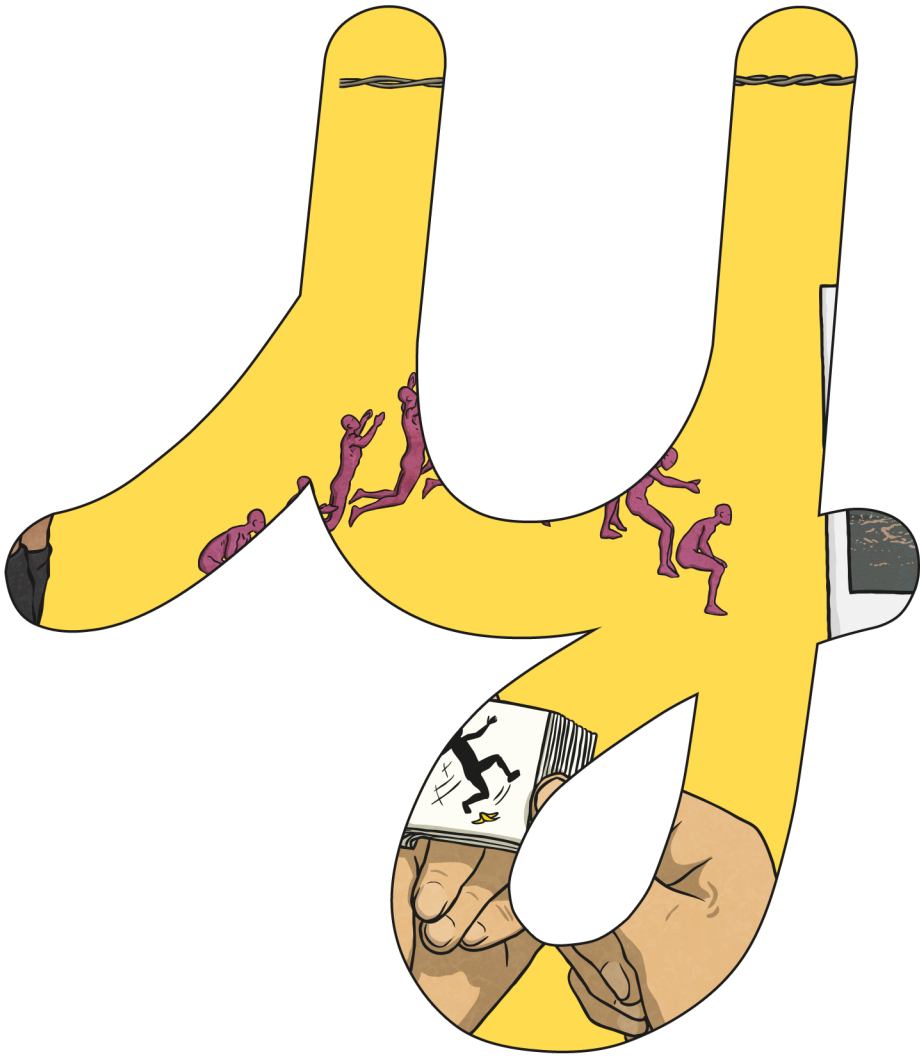

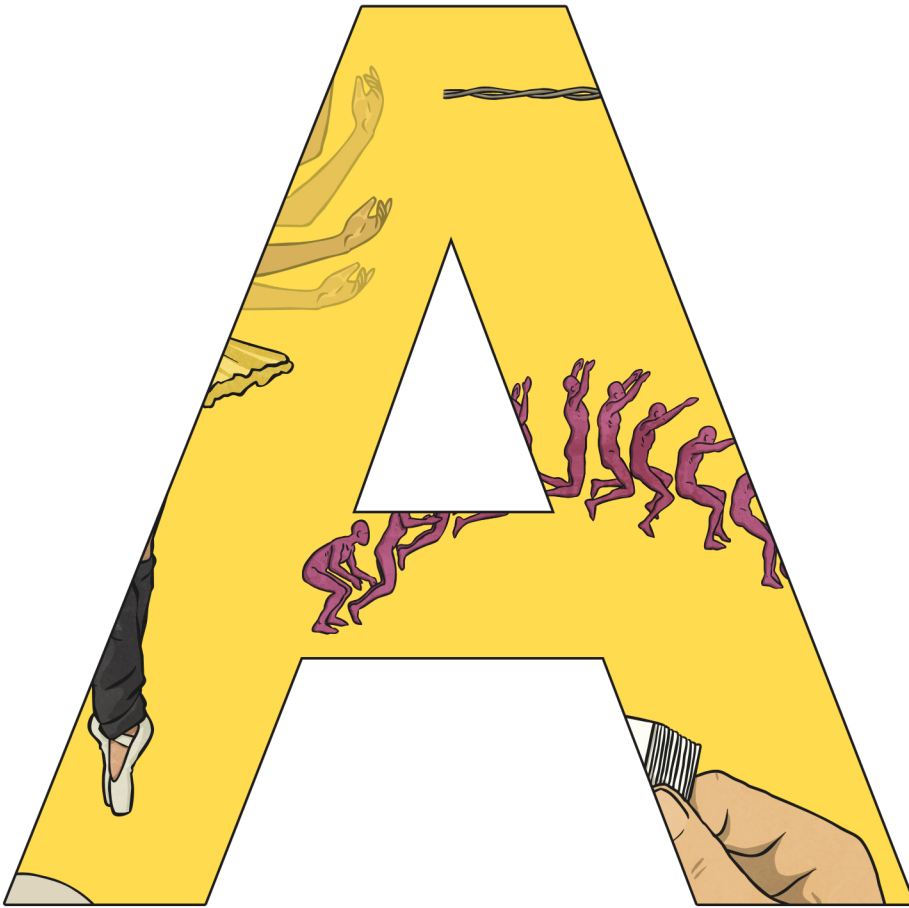

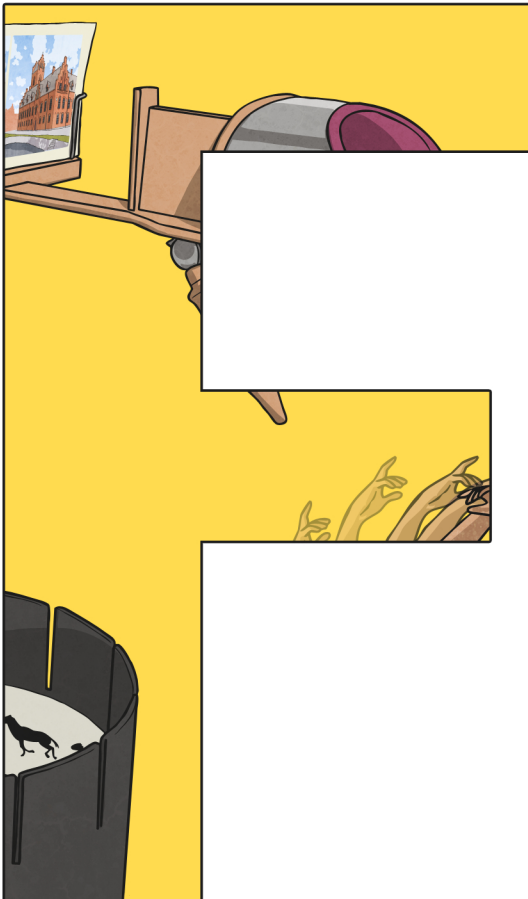
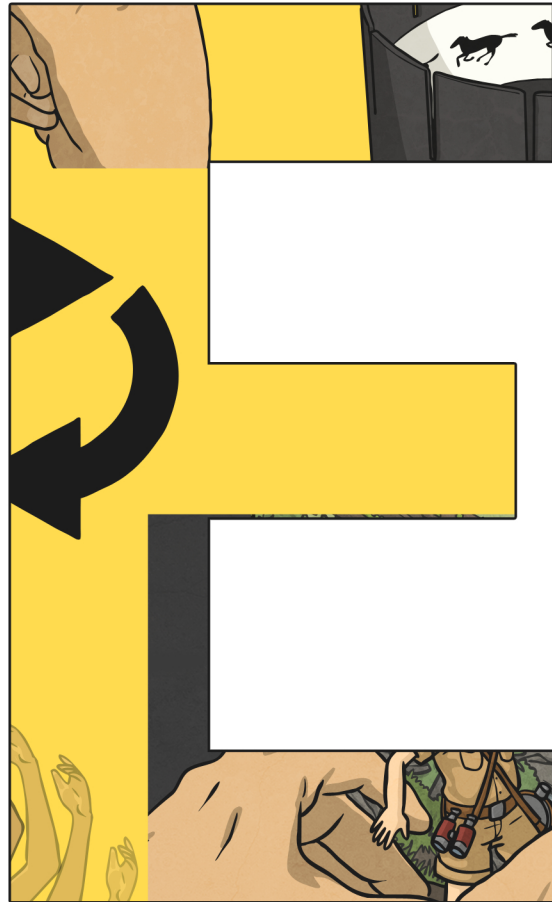
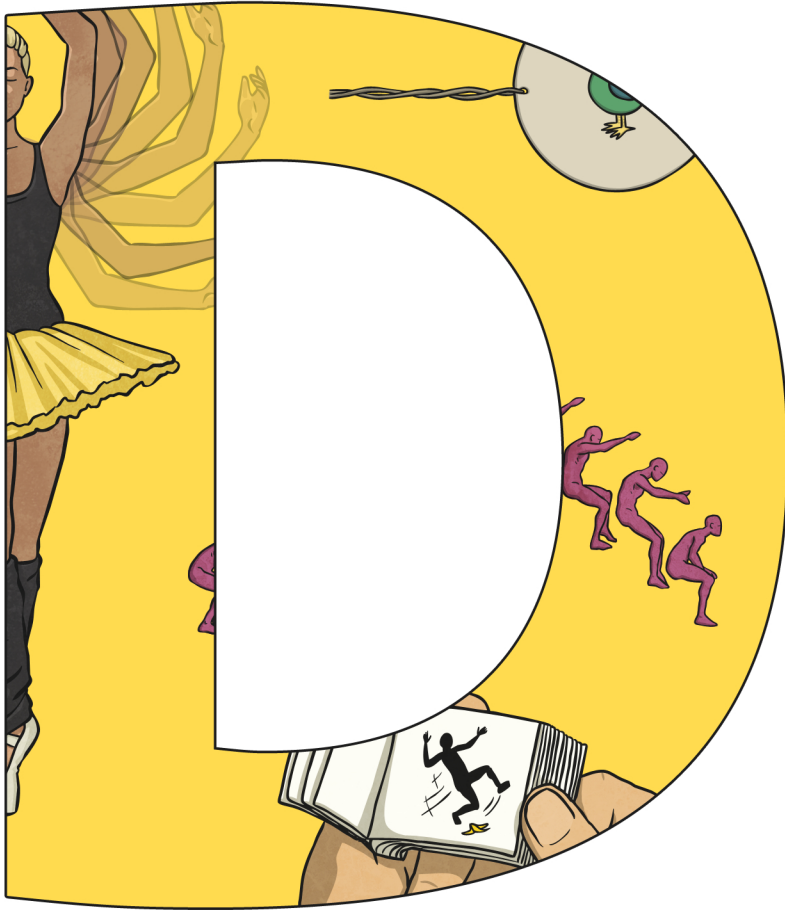

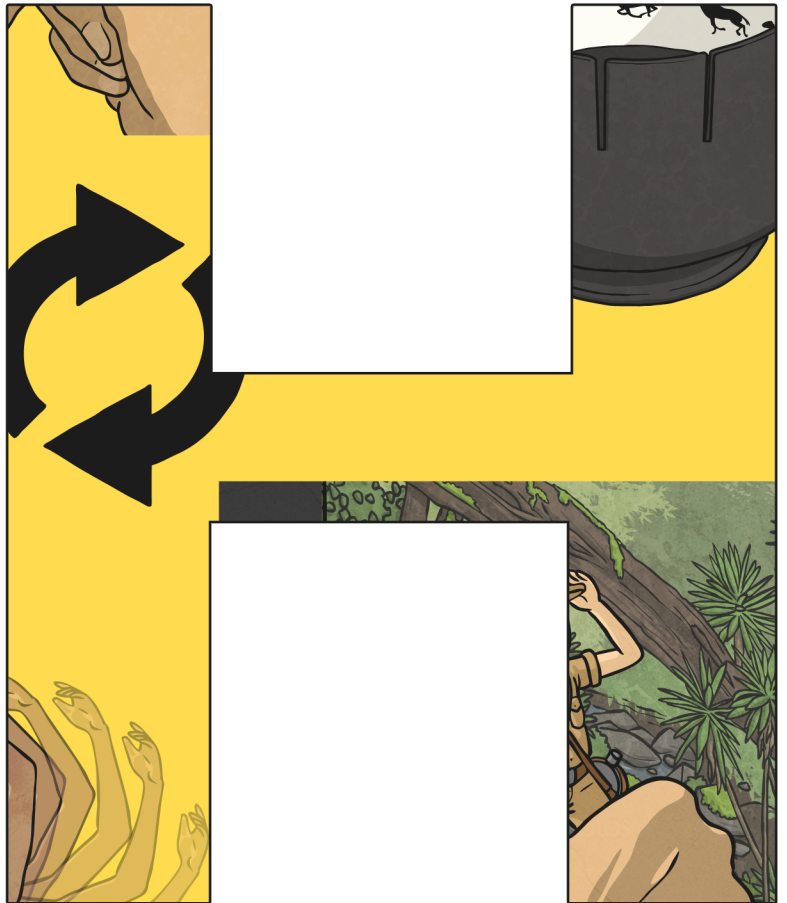
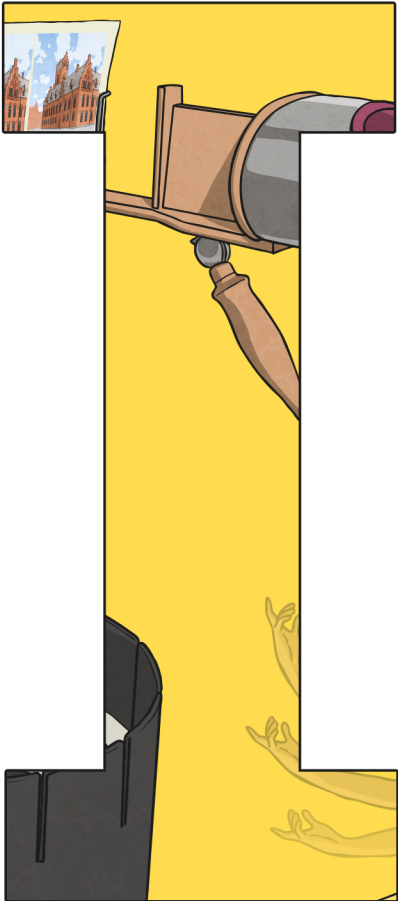
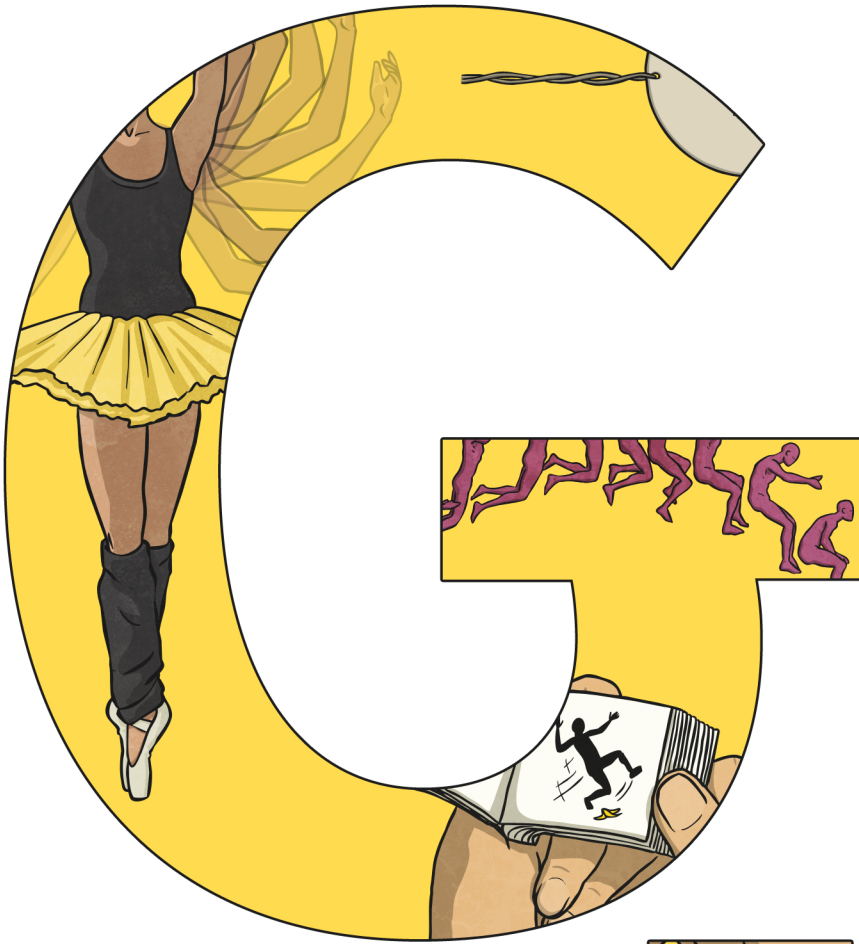







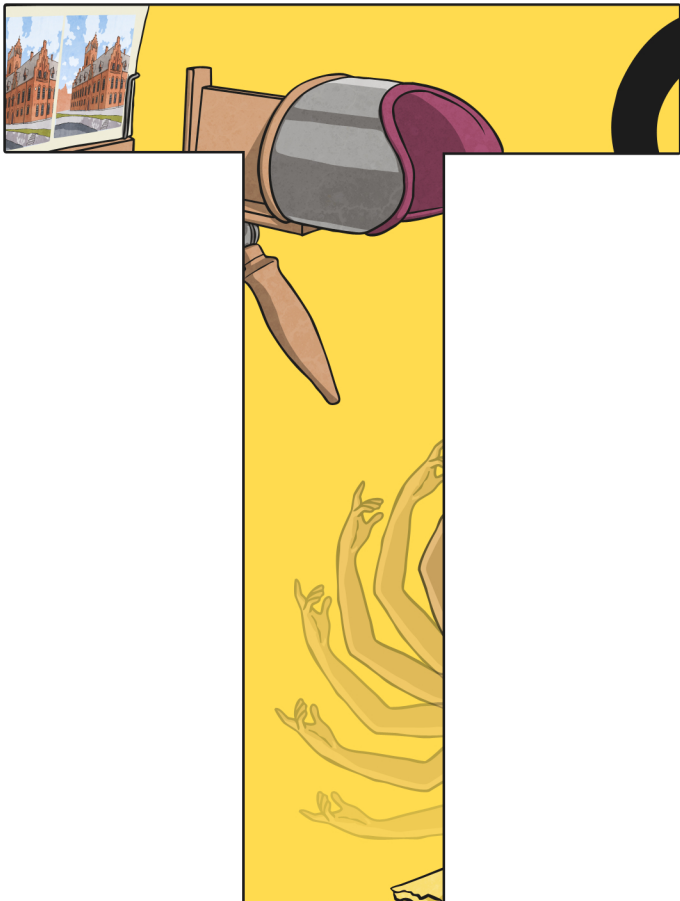

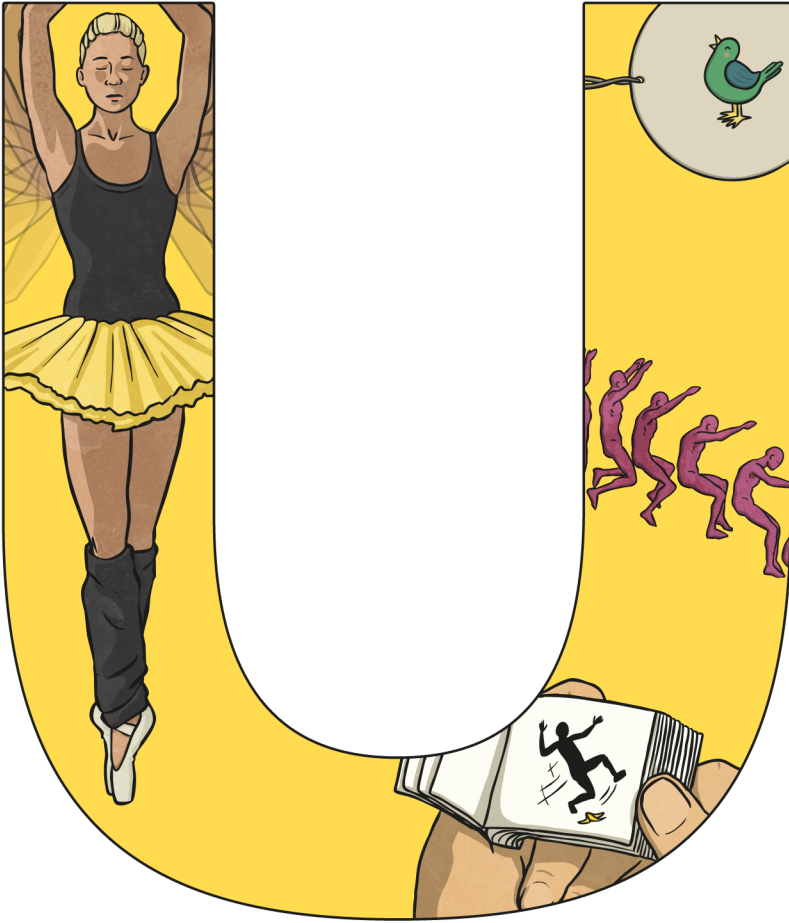



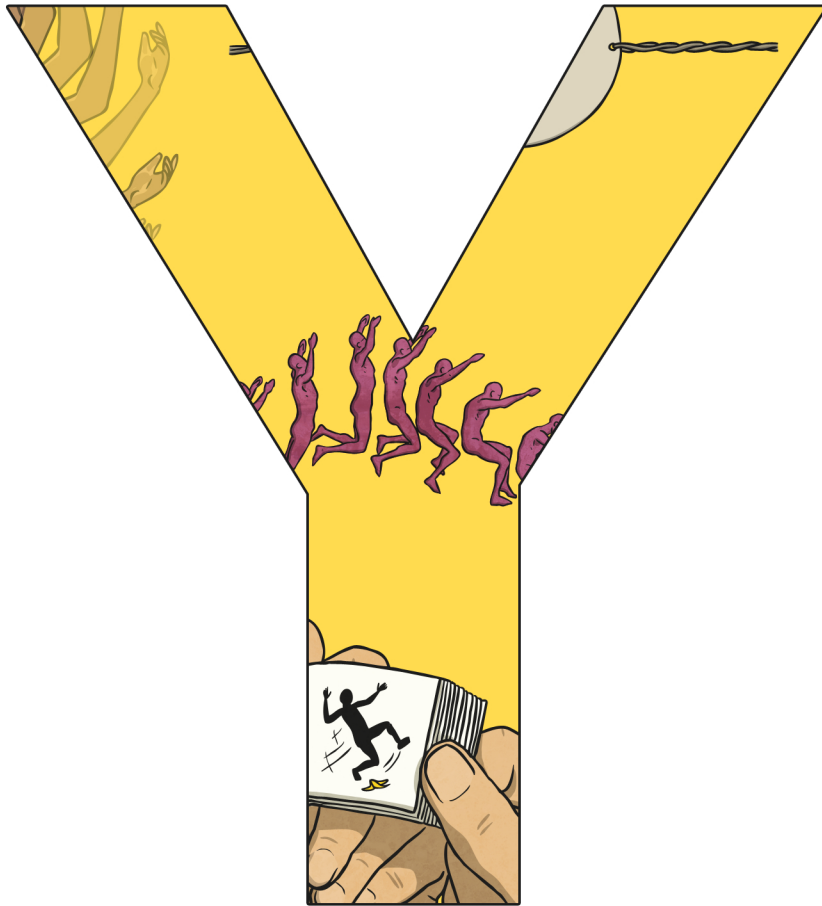

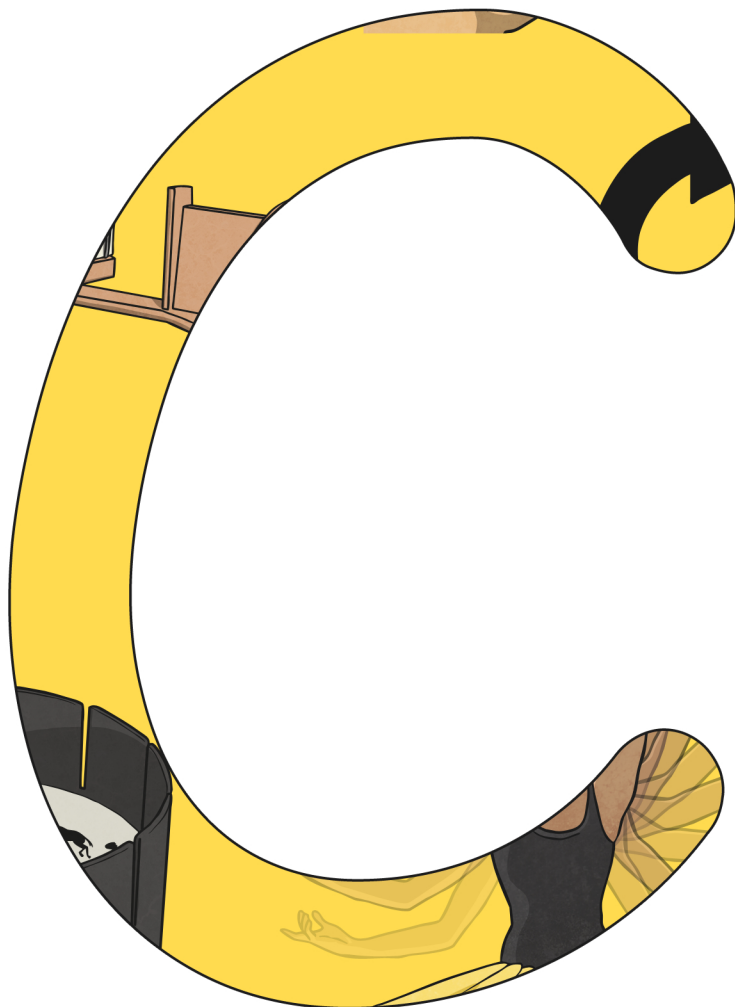
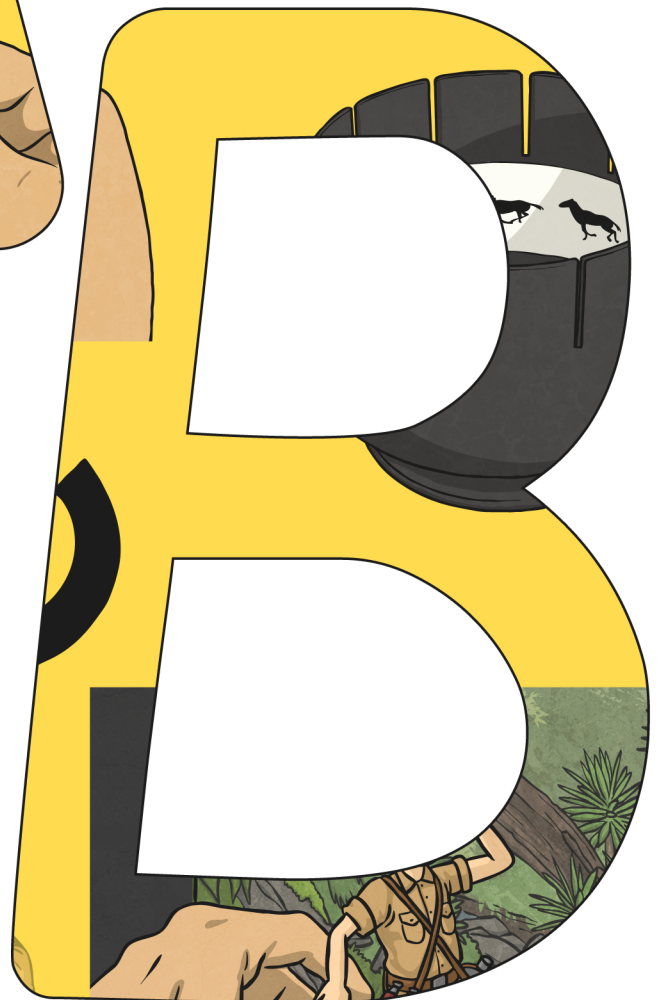
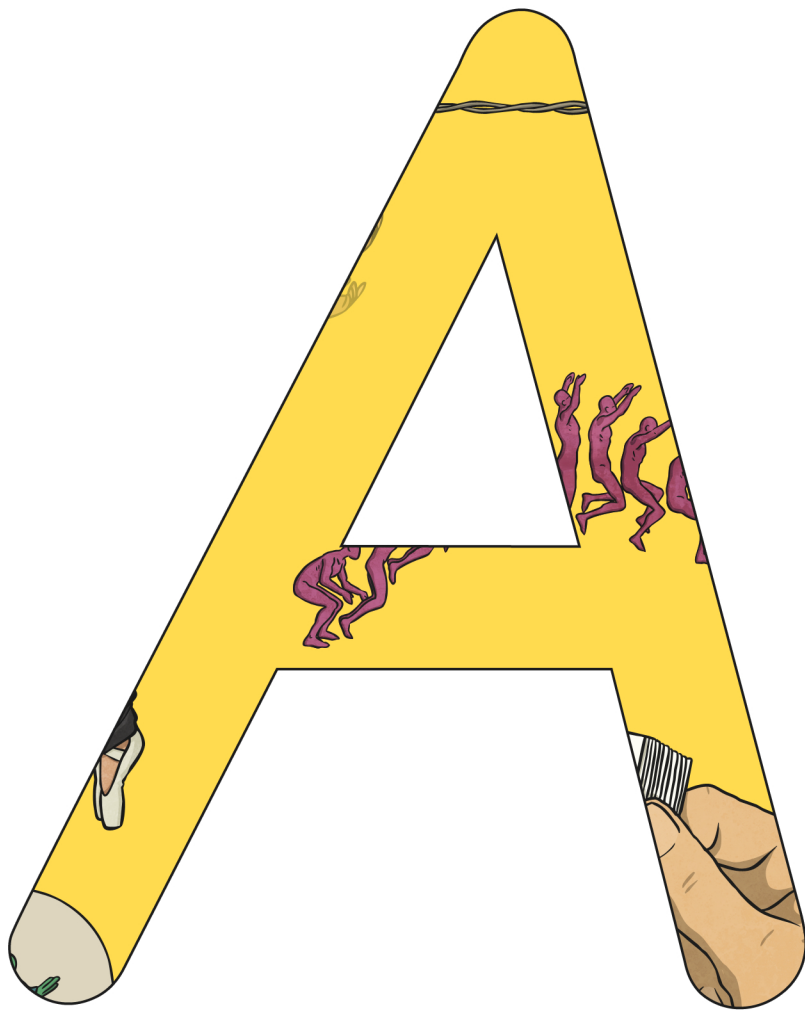

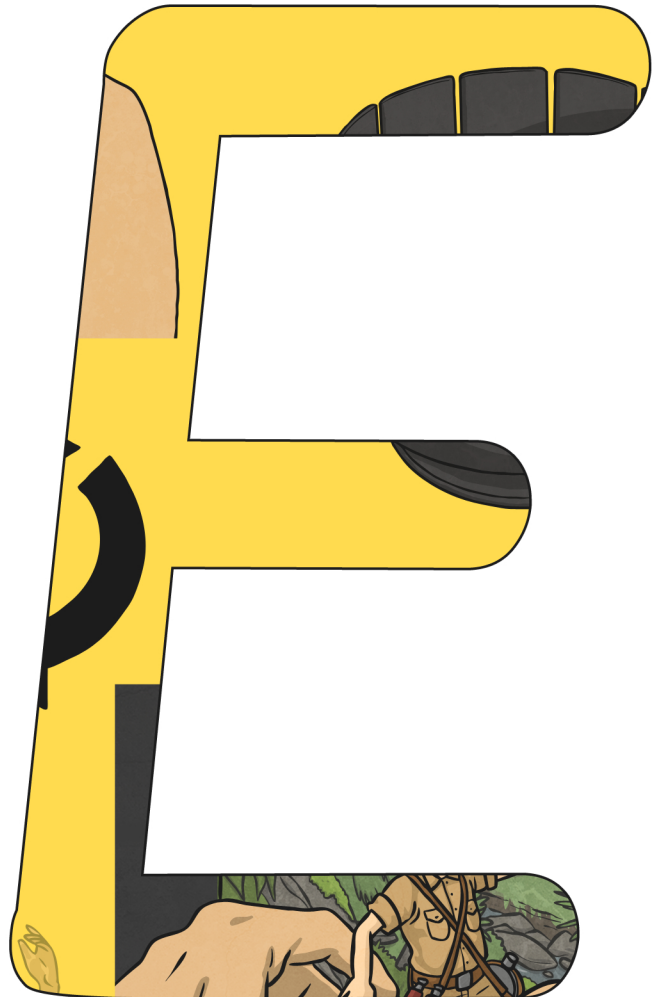
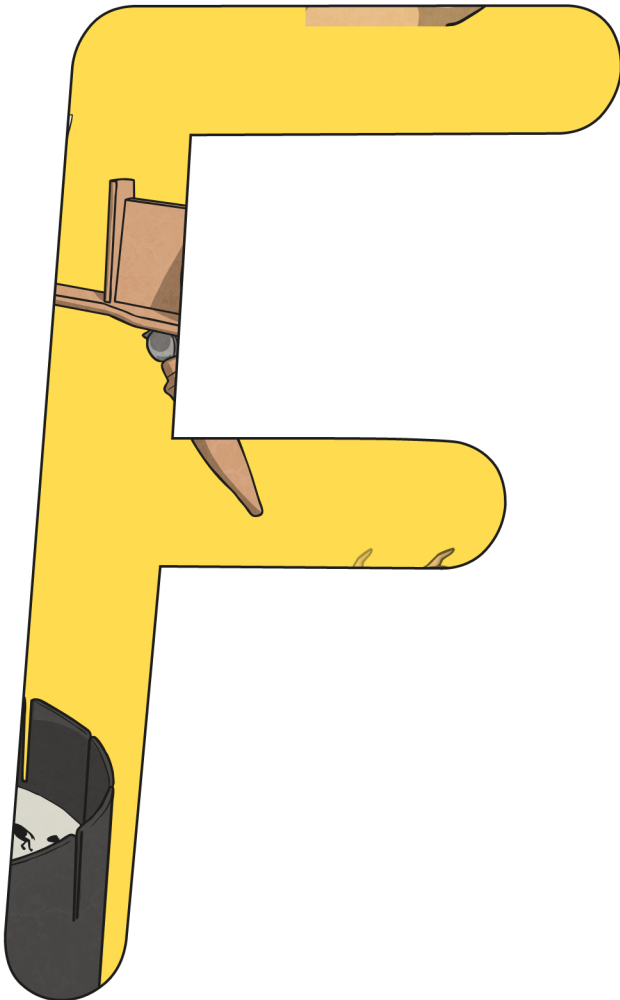
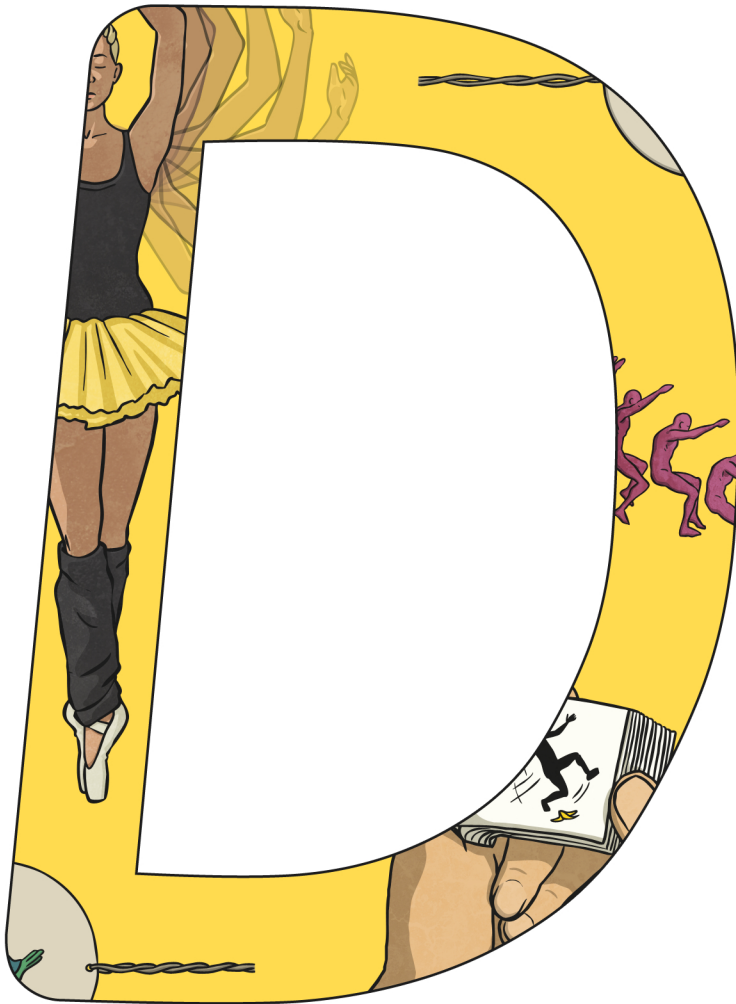

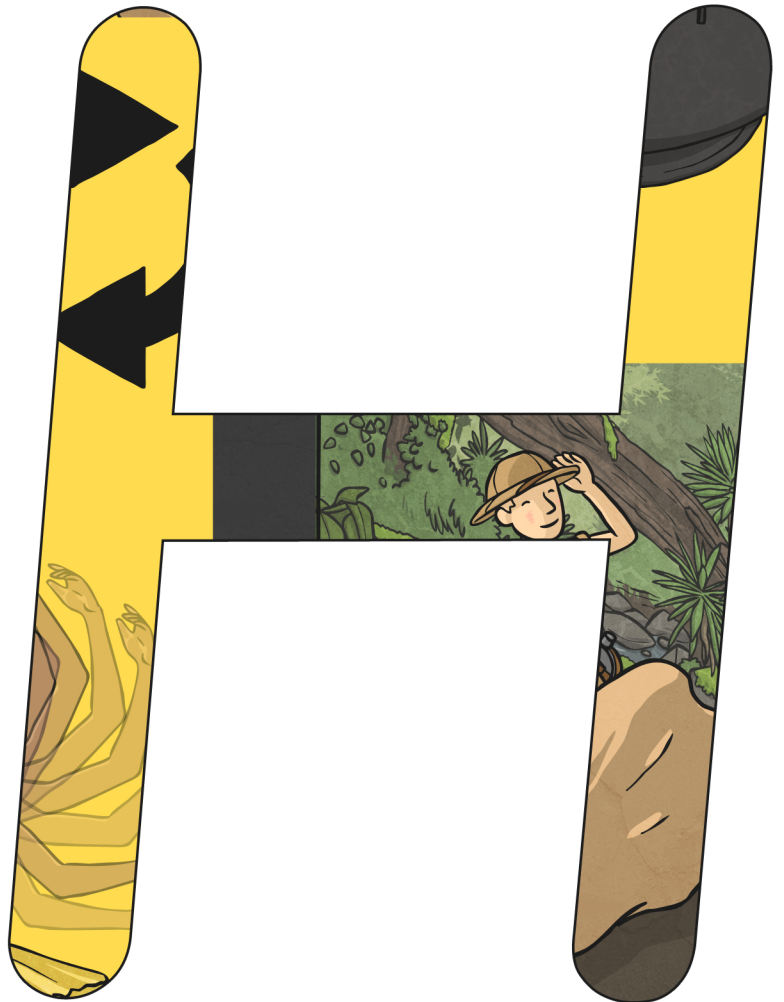
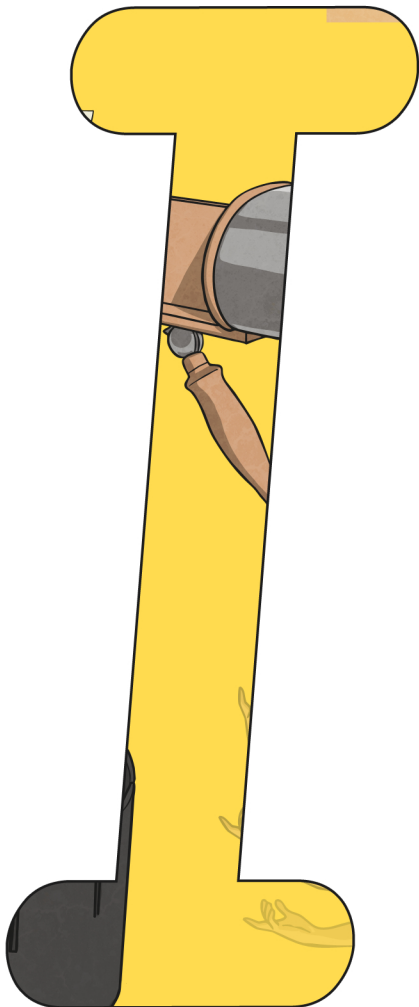
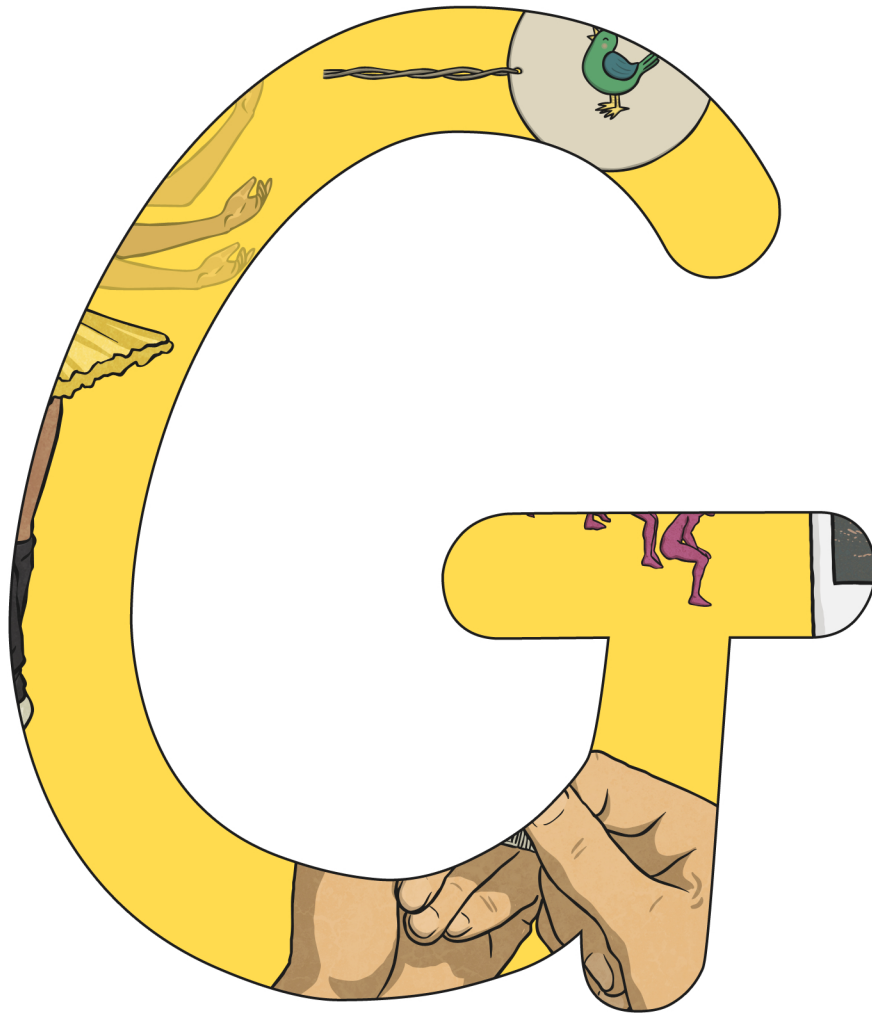

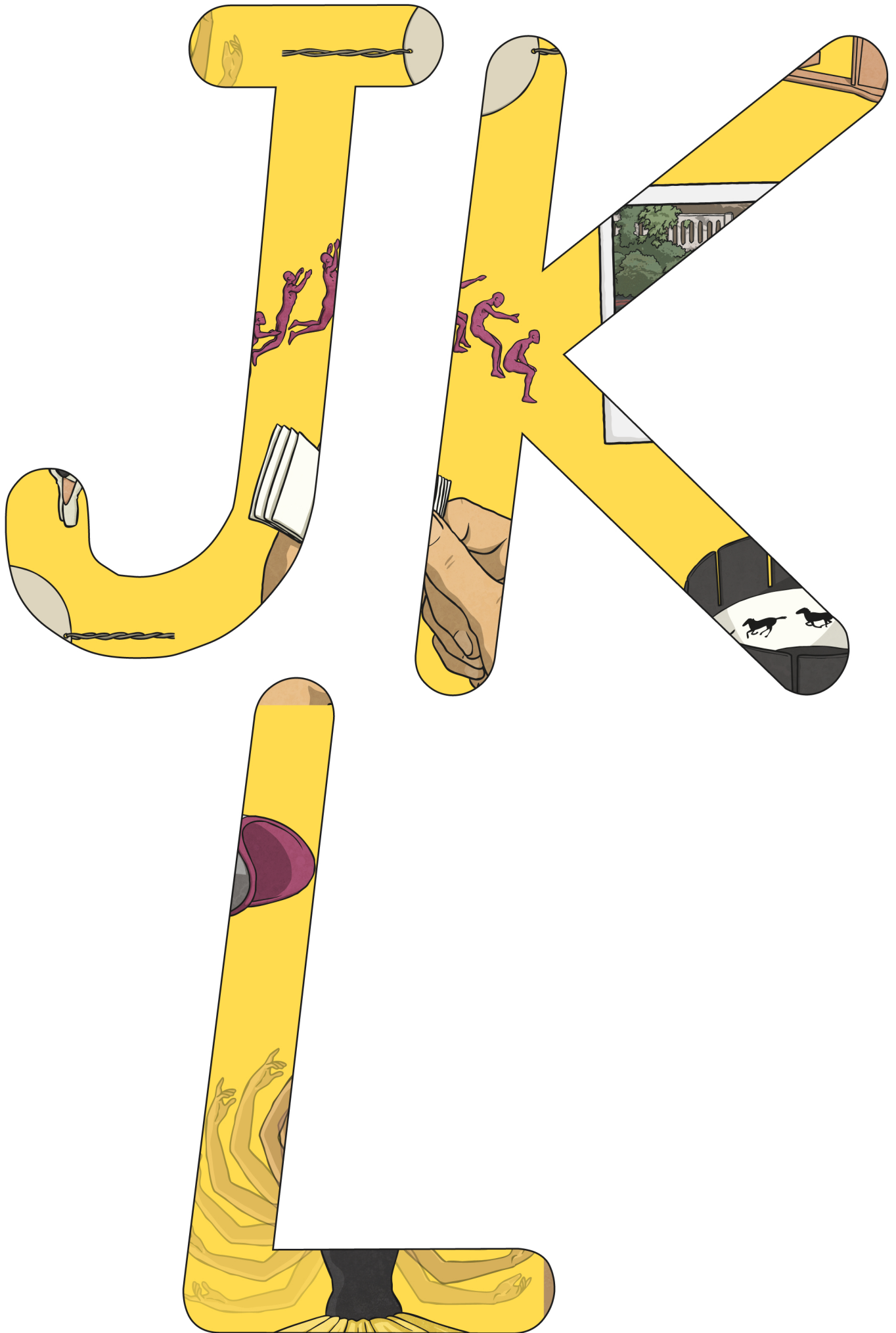



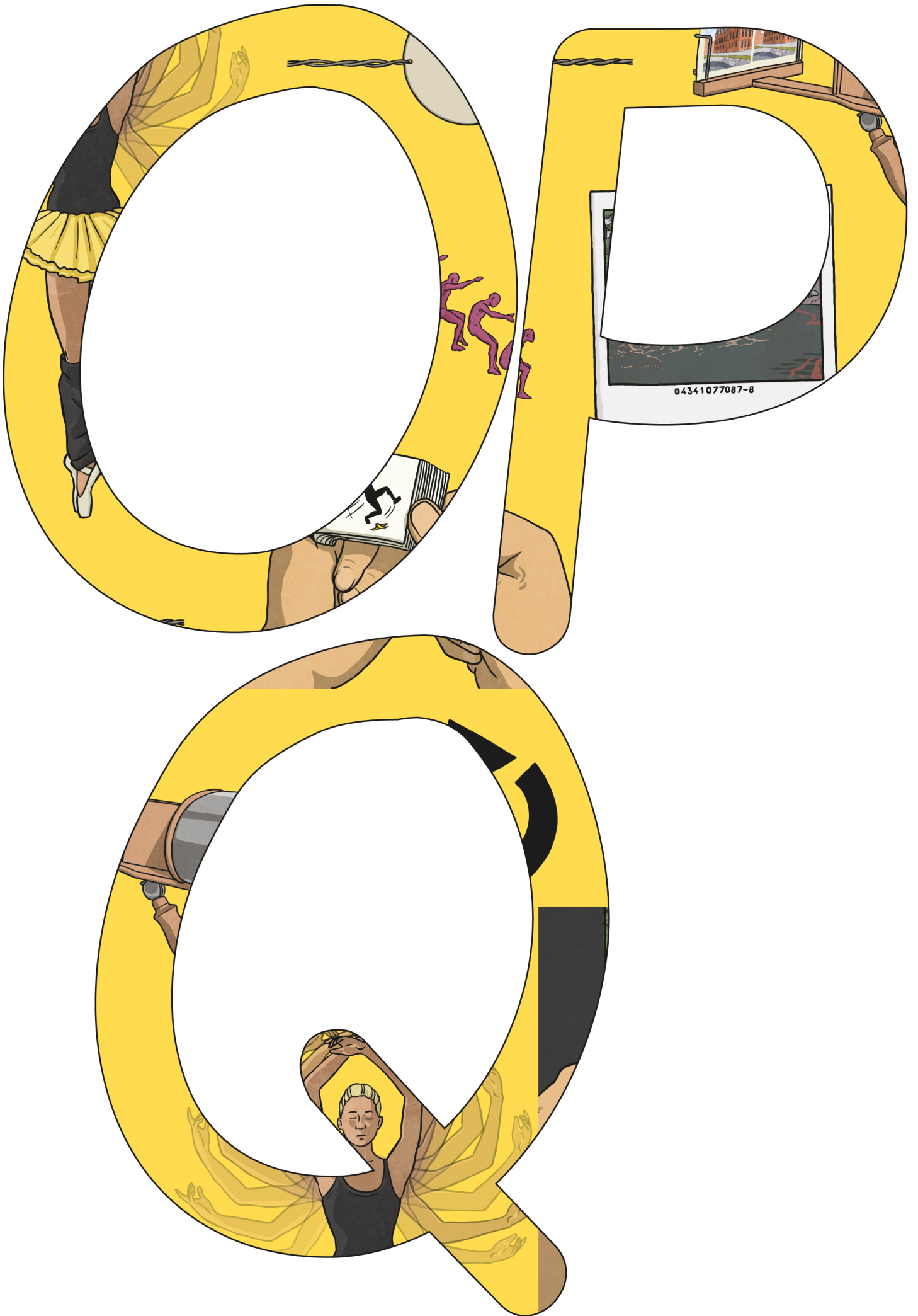

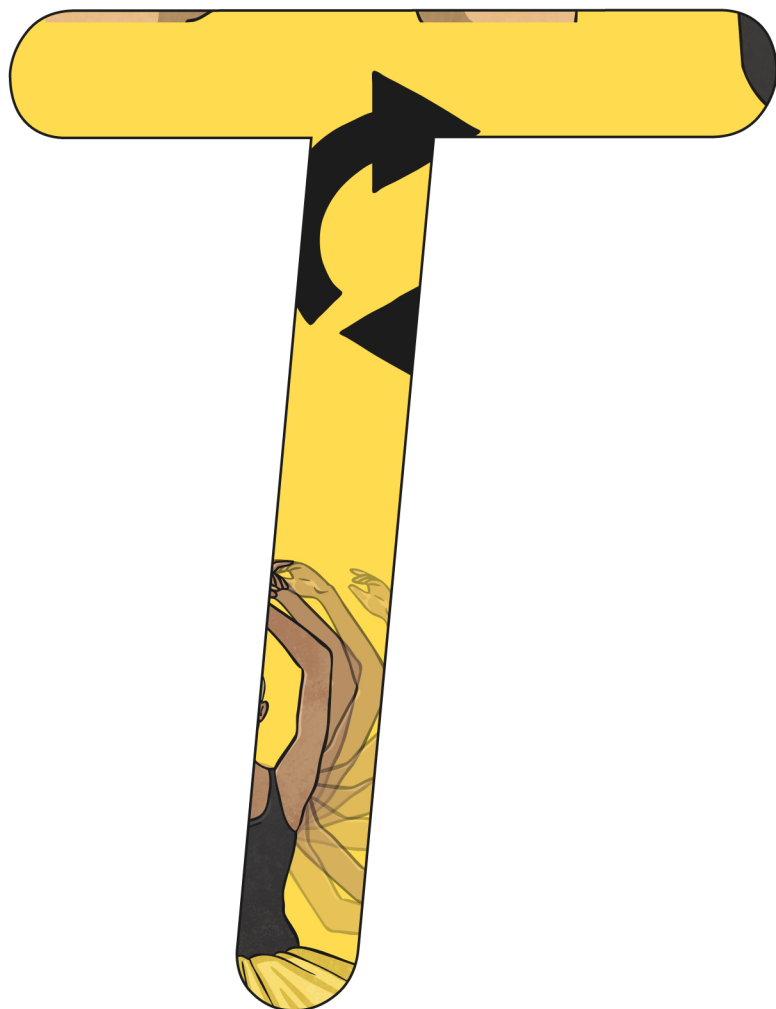





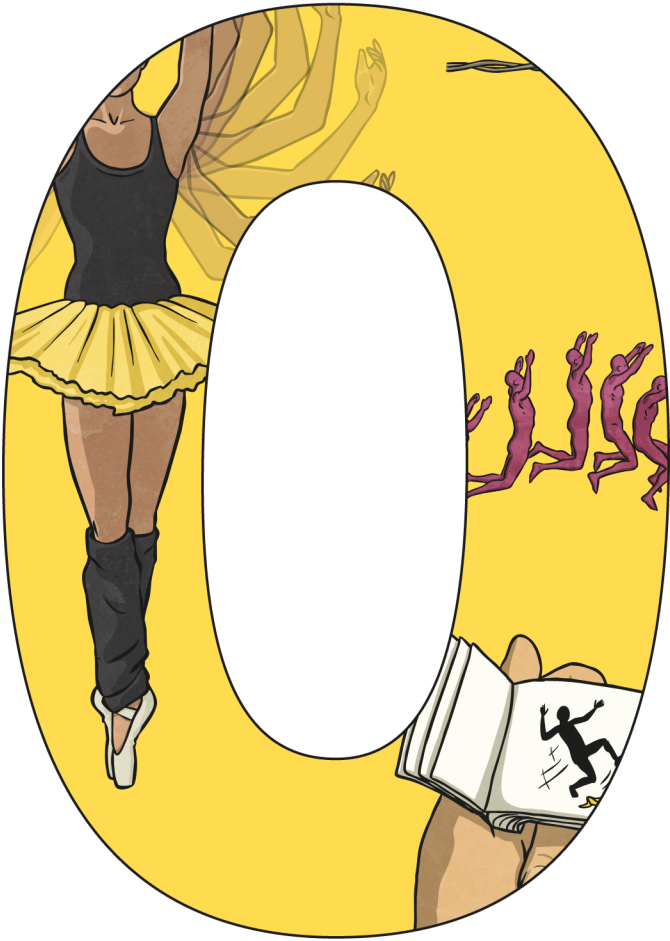

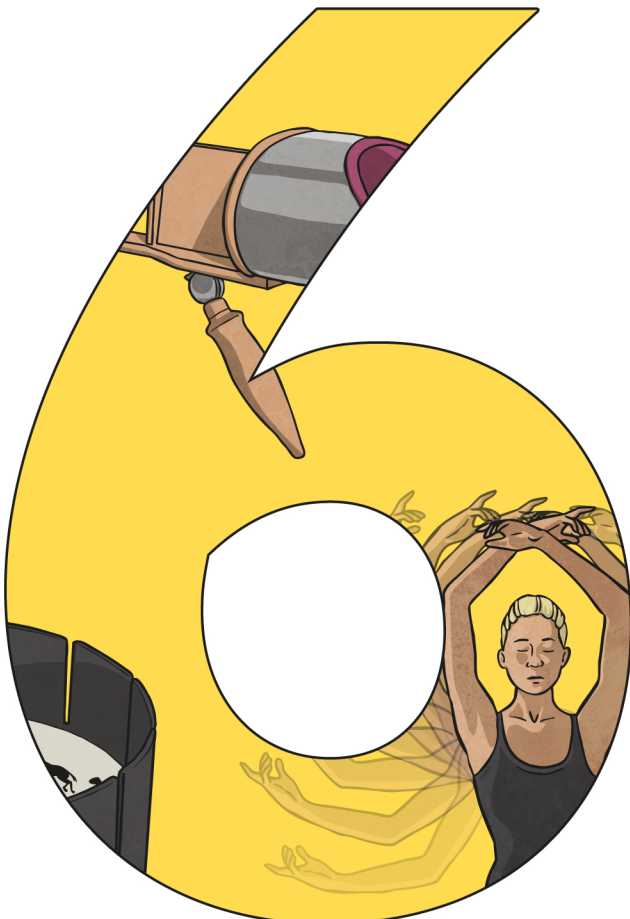



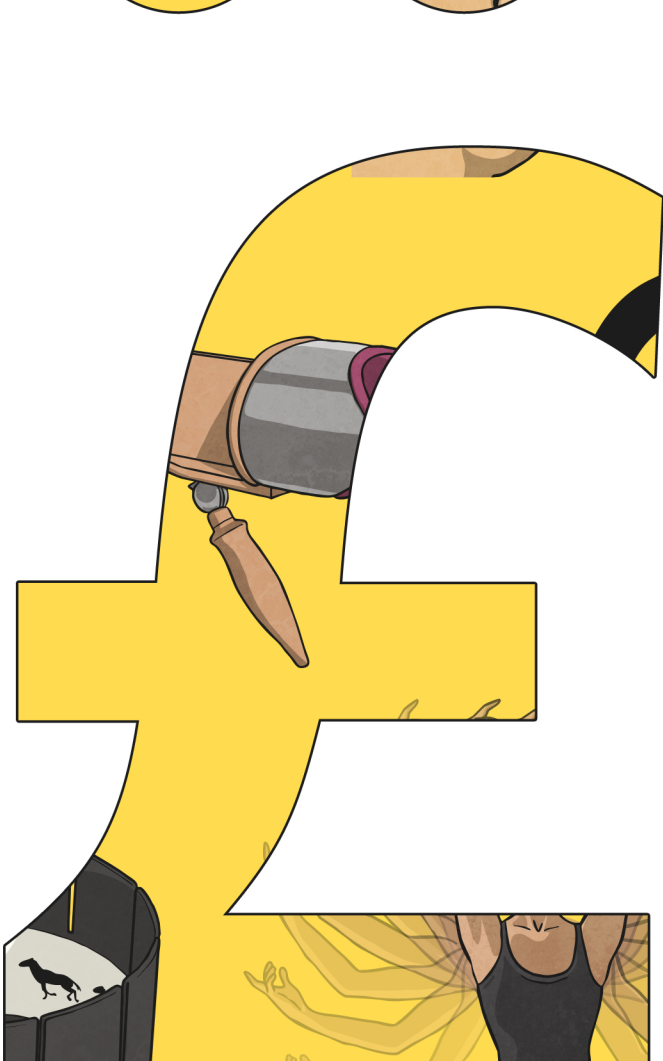
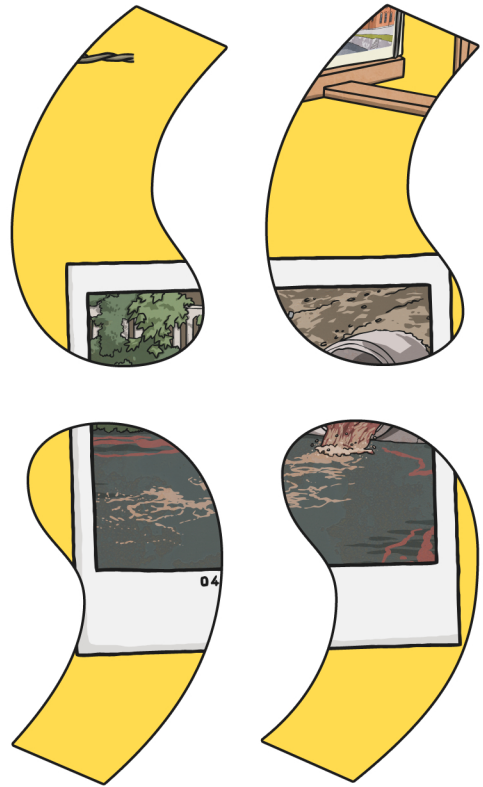

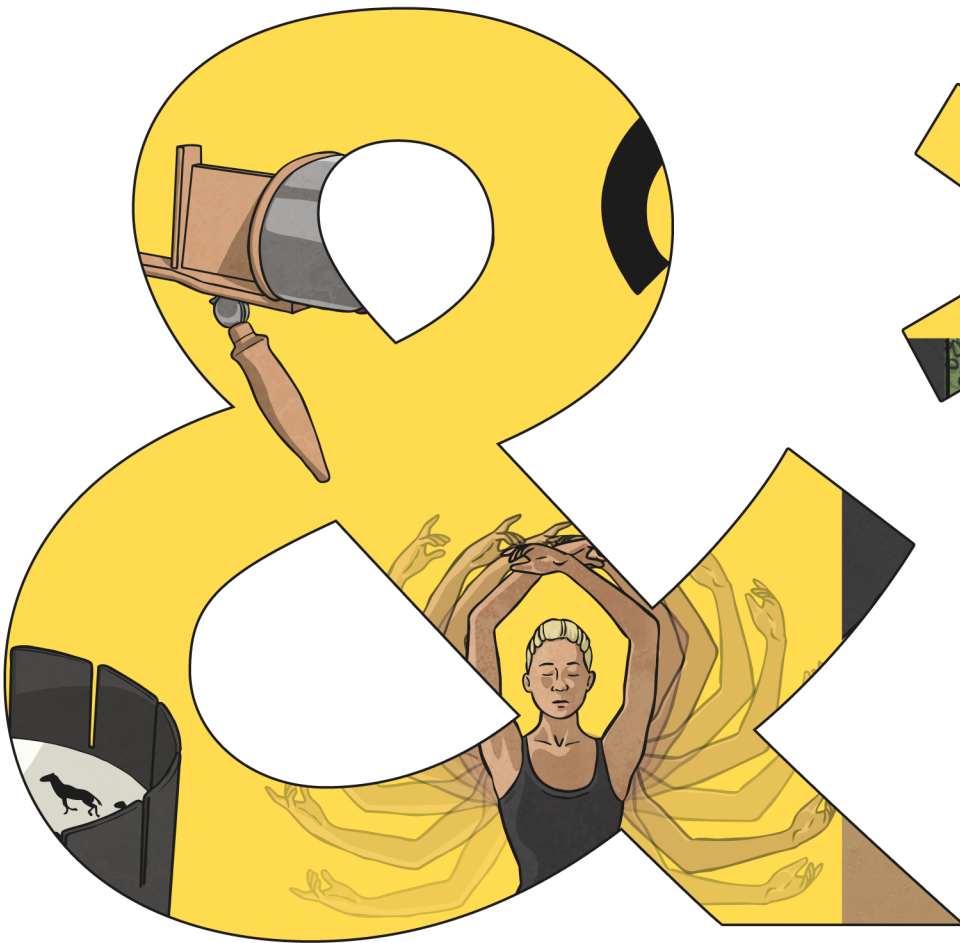
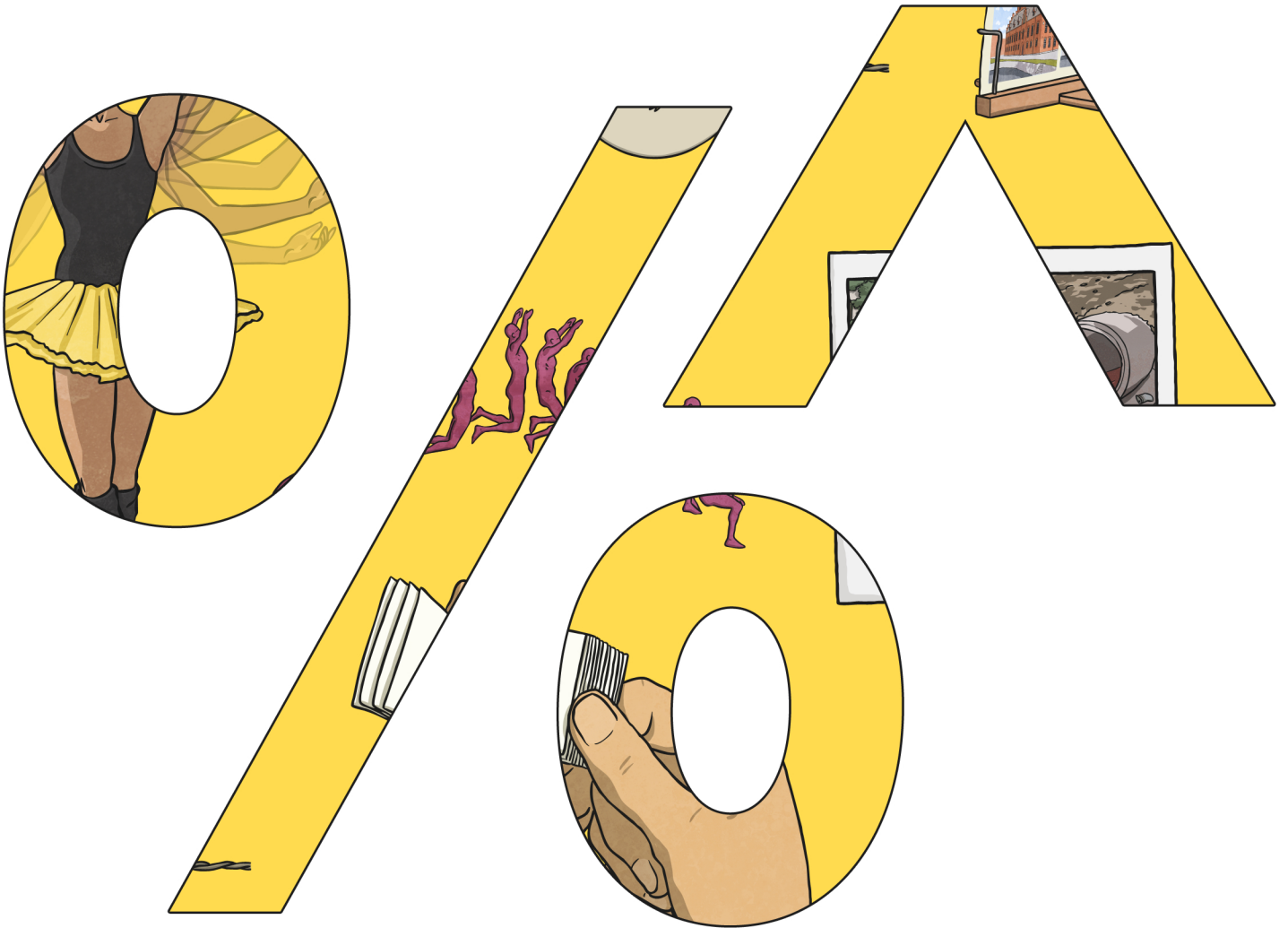

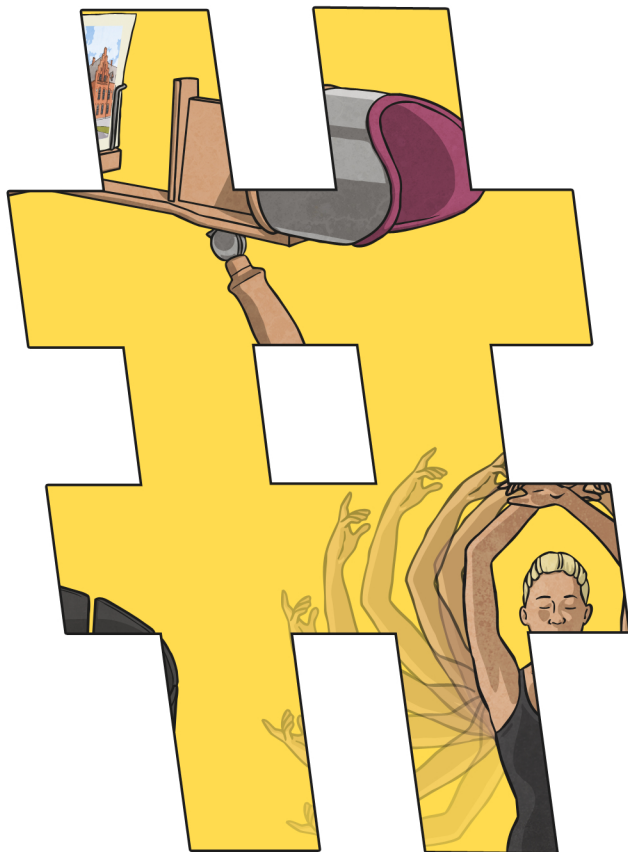
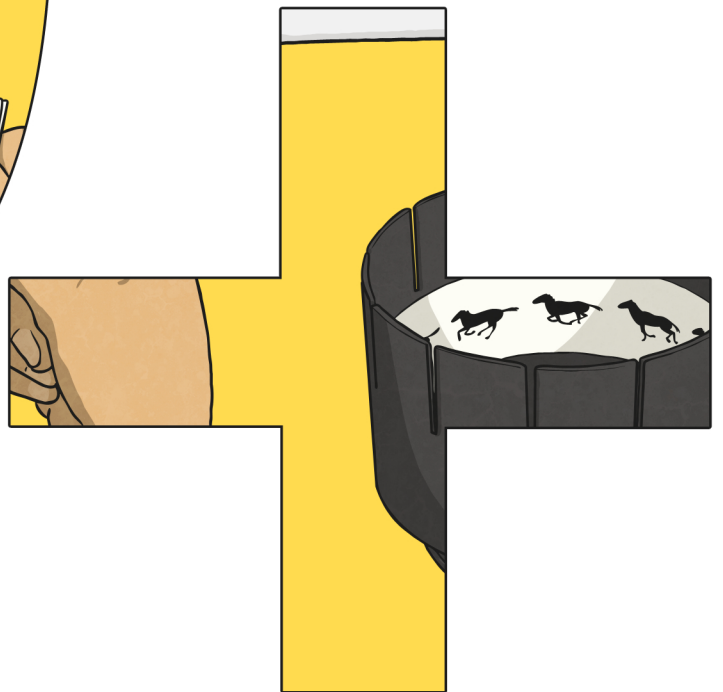
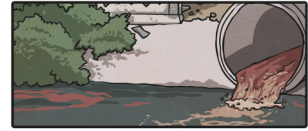
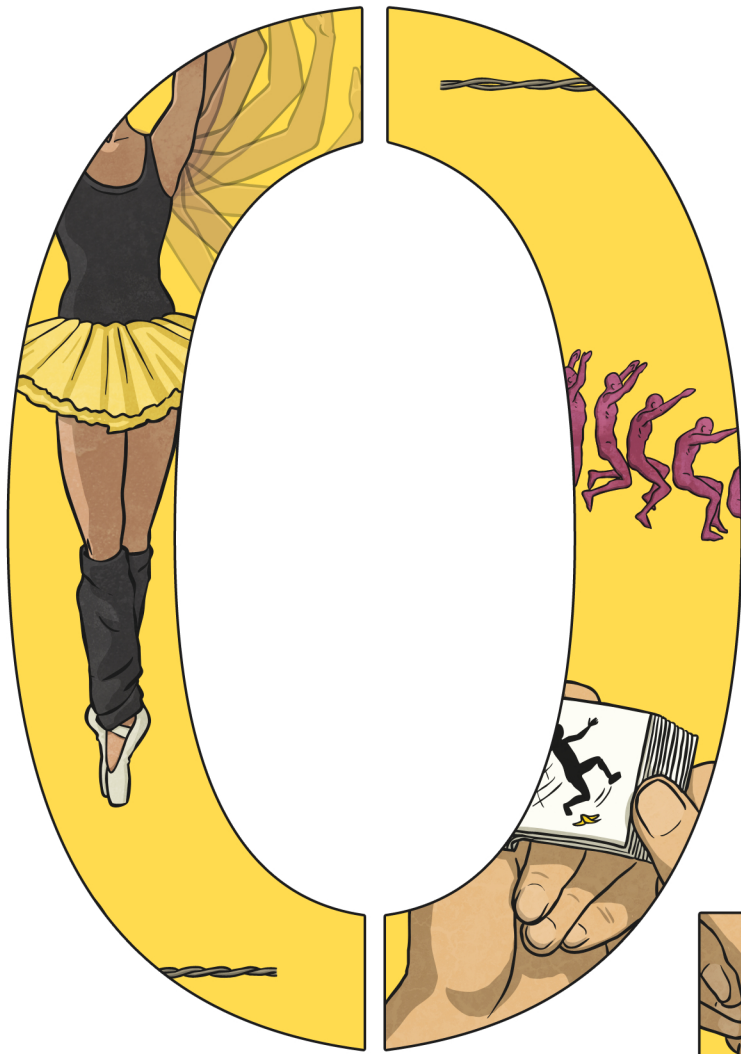

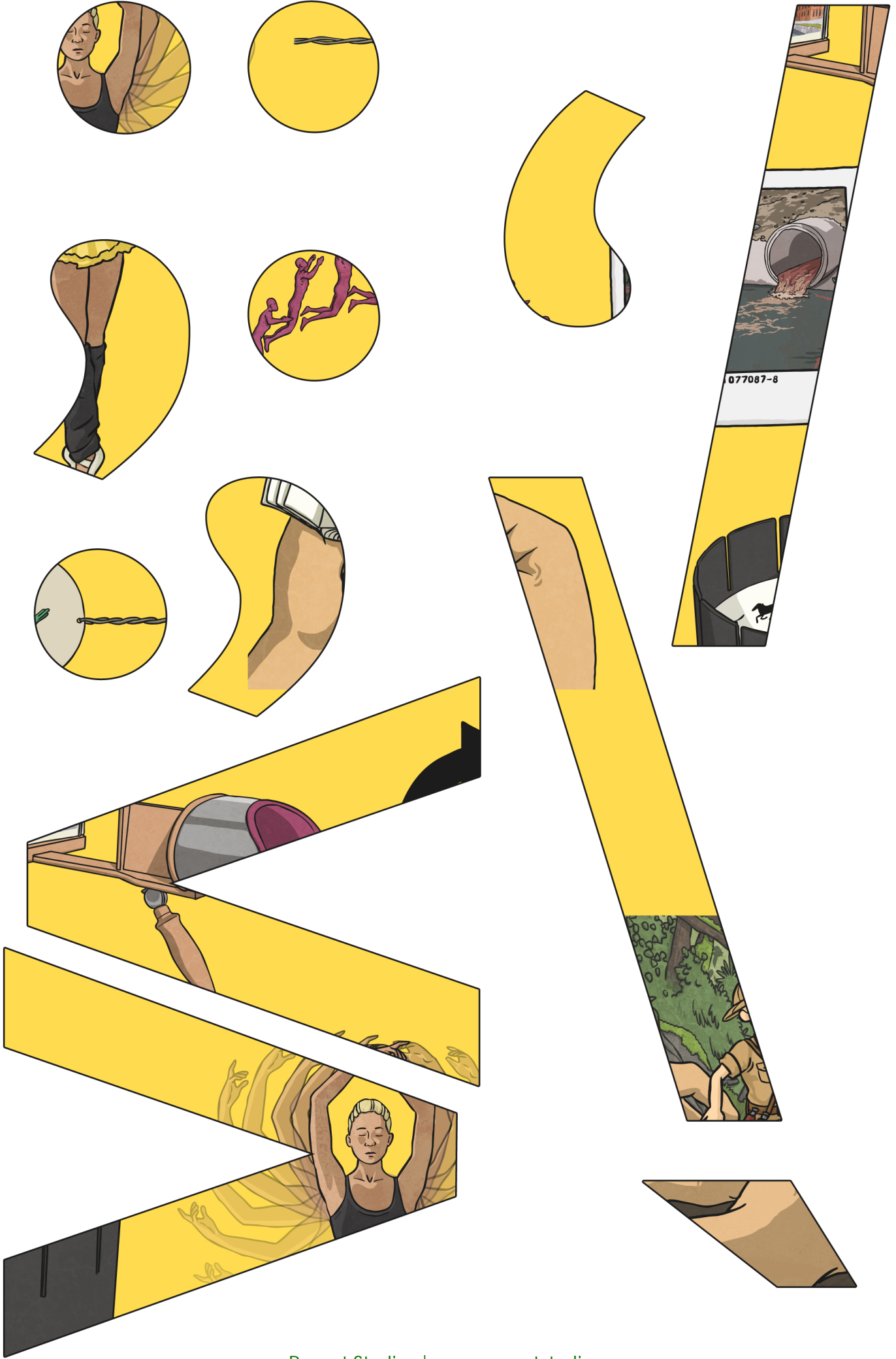



Anim

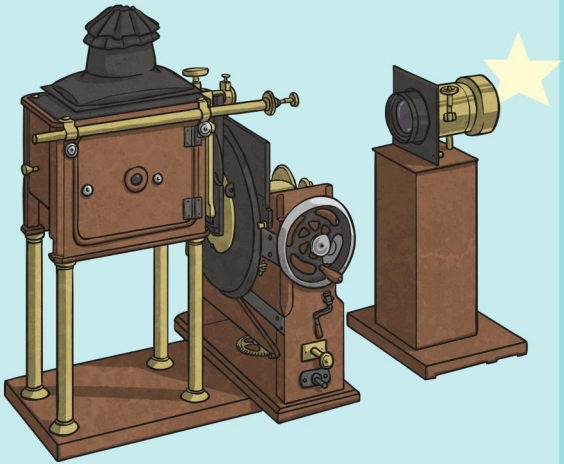

zoopraxiscope

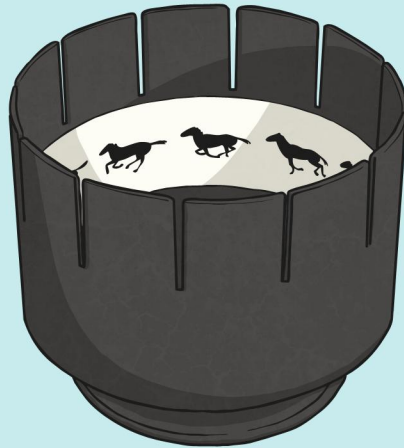

zoetrope

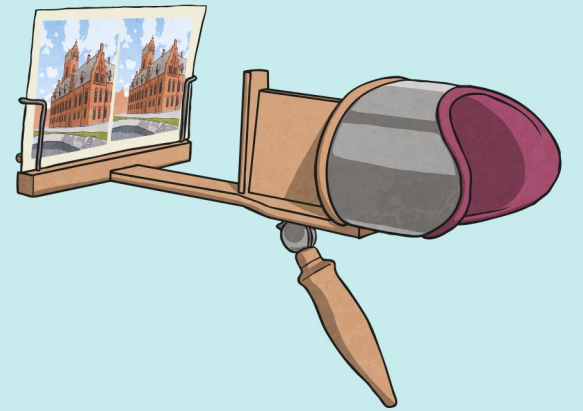

stereoscope



onion skinning



still image



stick man

Animation



flip book

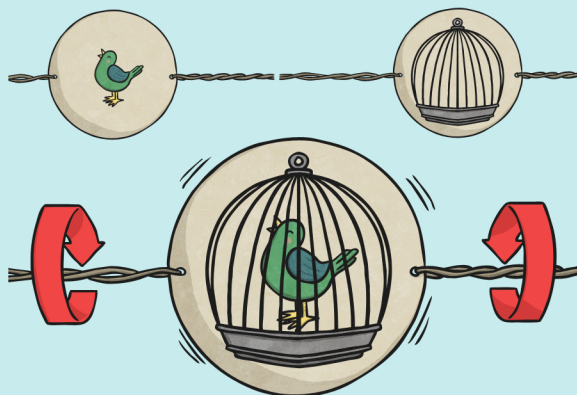

thaumatrope

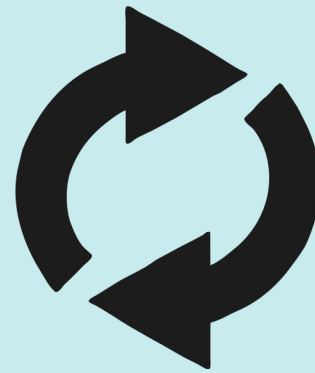

loop

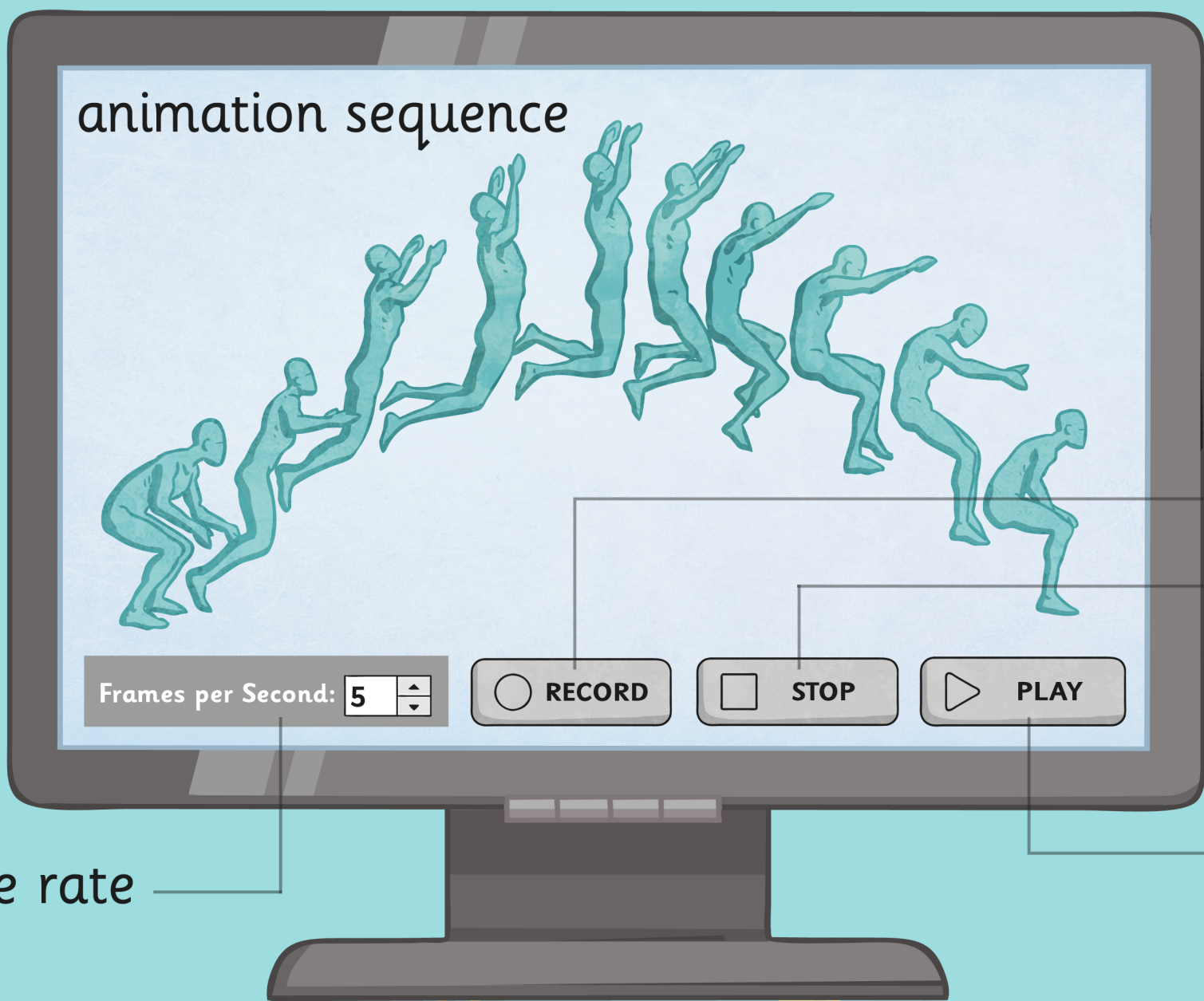

frame rate

record
stop

play

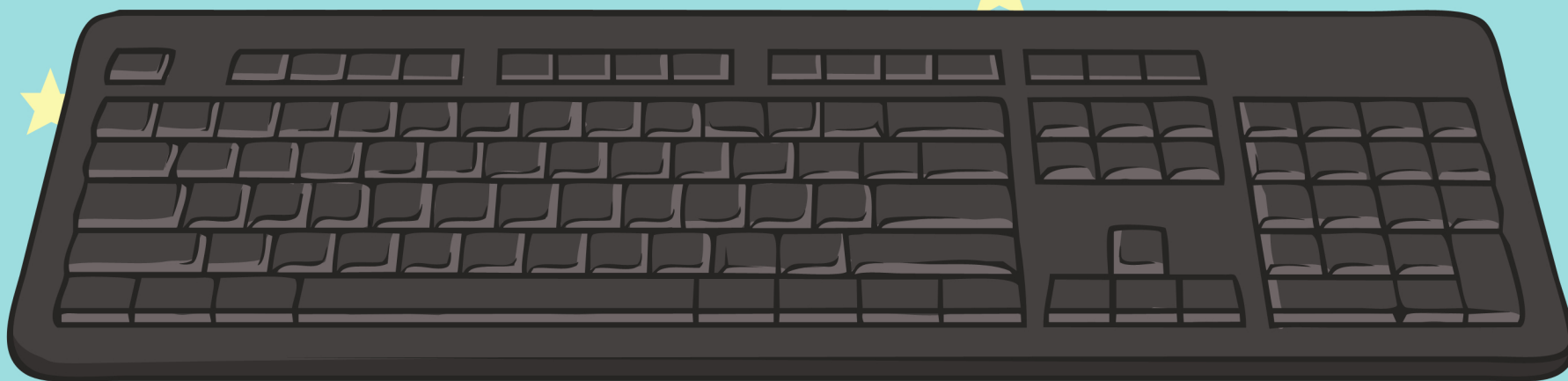

Anim

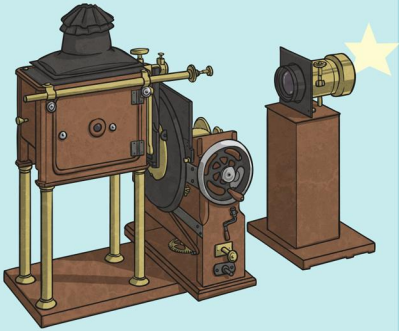

zoopraxiscope



zoetrope

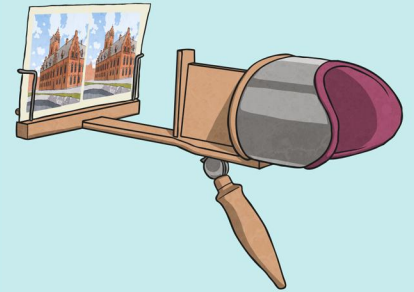

stereoscope



onion skinning



still image



stick man

Animation



flip book

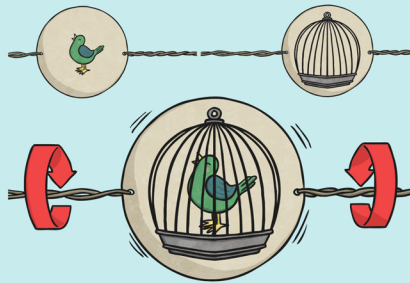

thaumatrope

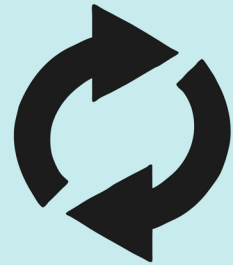

loop

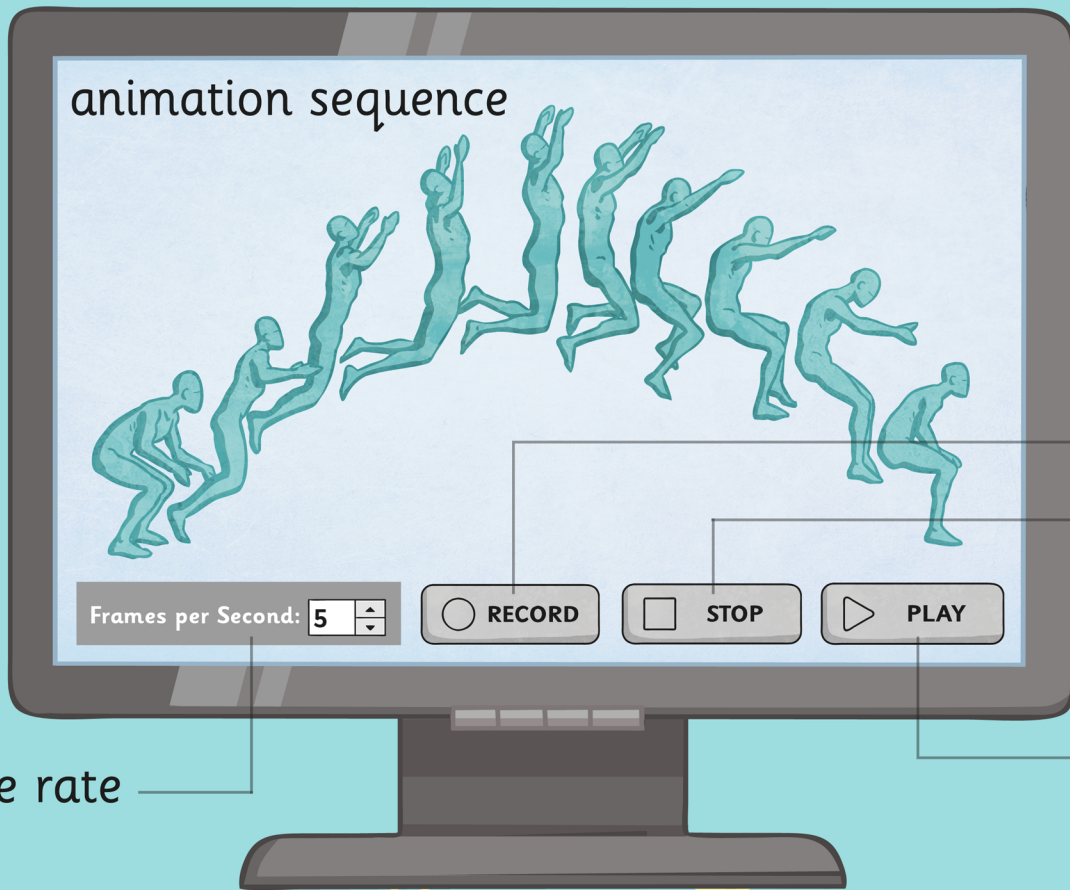

frame rate

record
stop

play

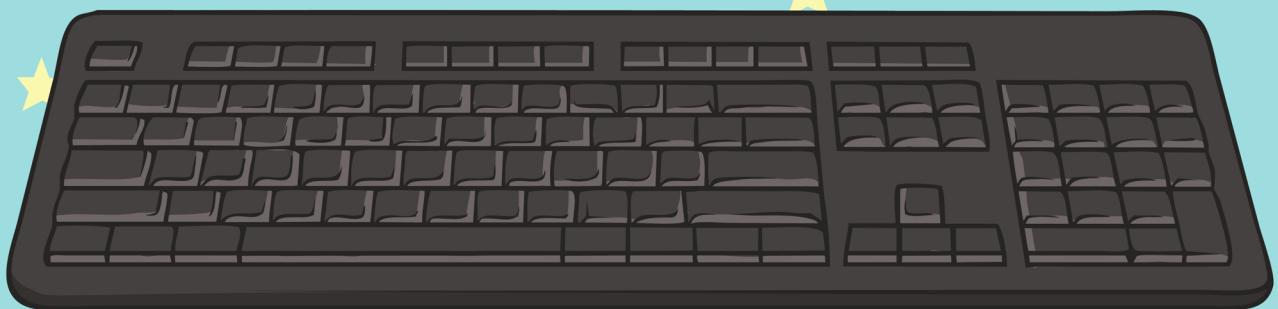

Anim

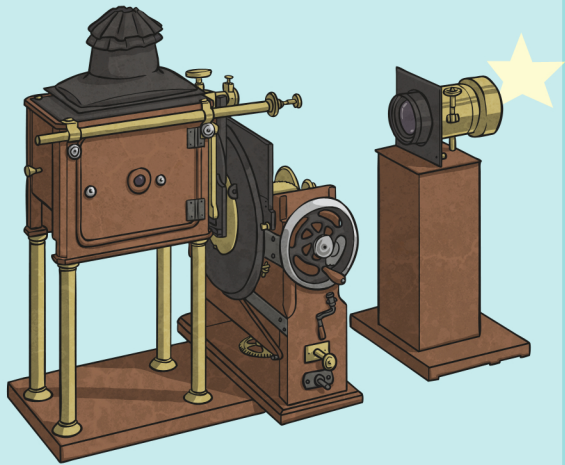

zoopraxiscope



zoetrope

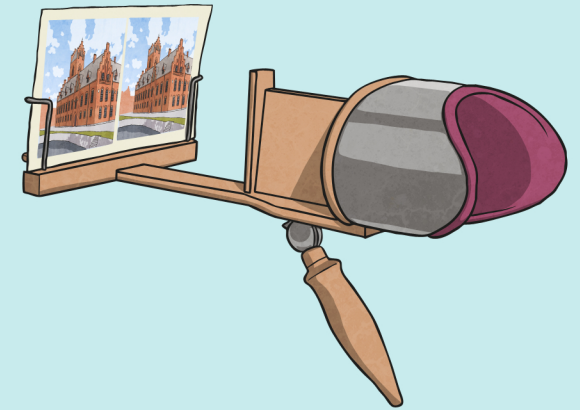

stereoscope

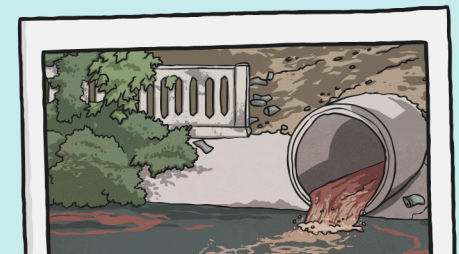
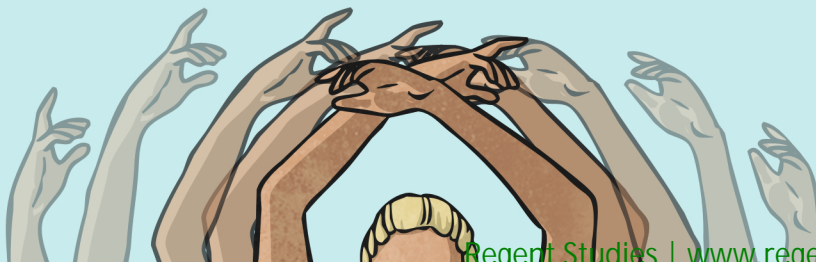

Animation

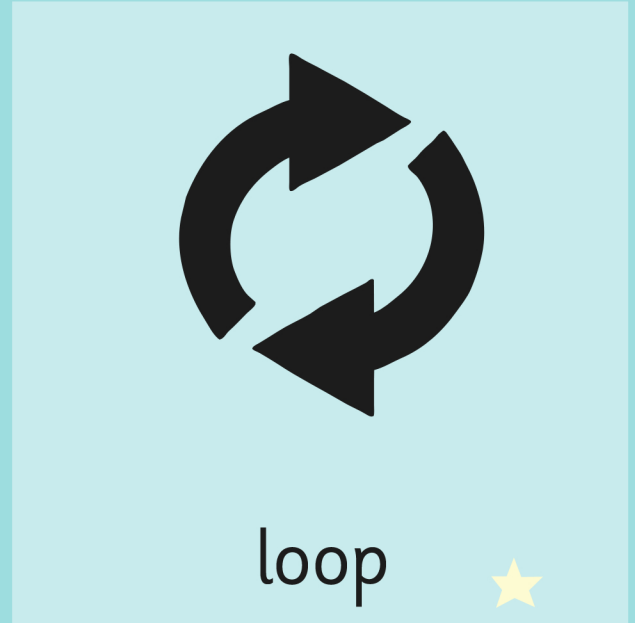



onion skinning

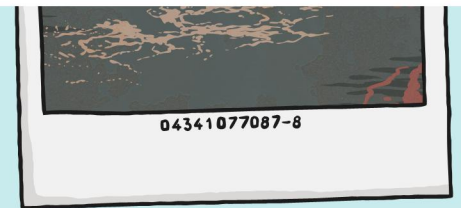

still image



stick man

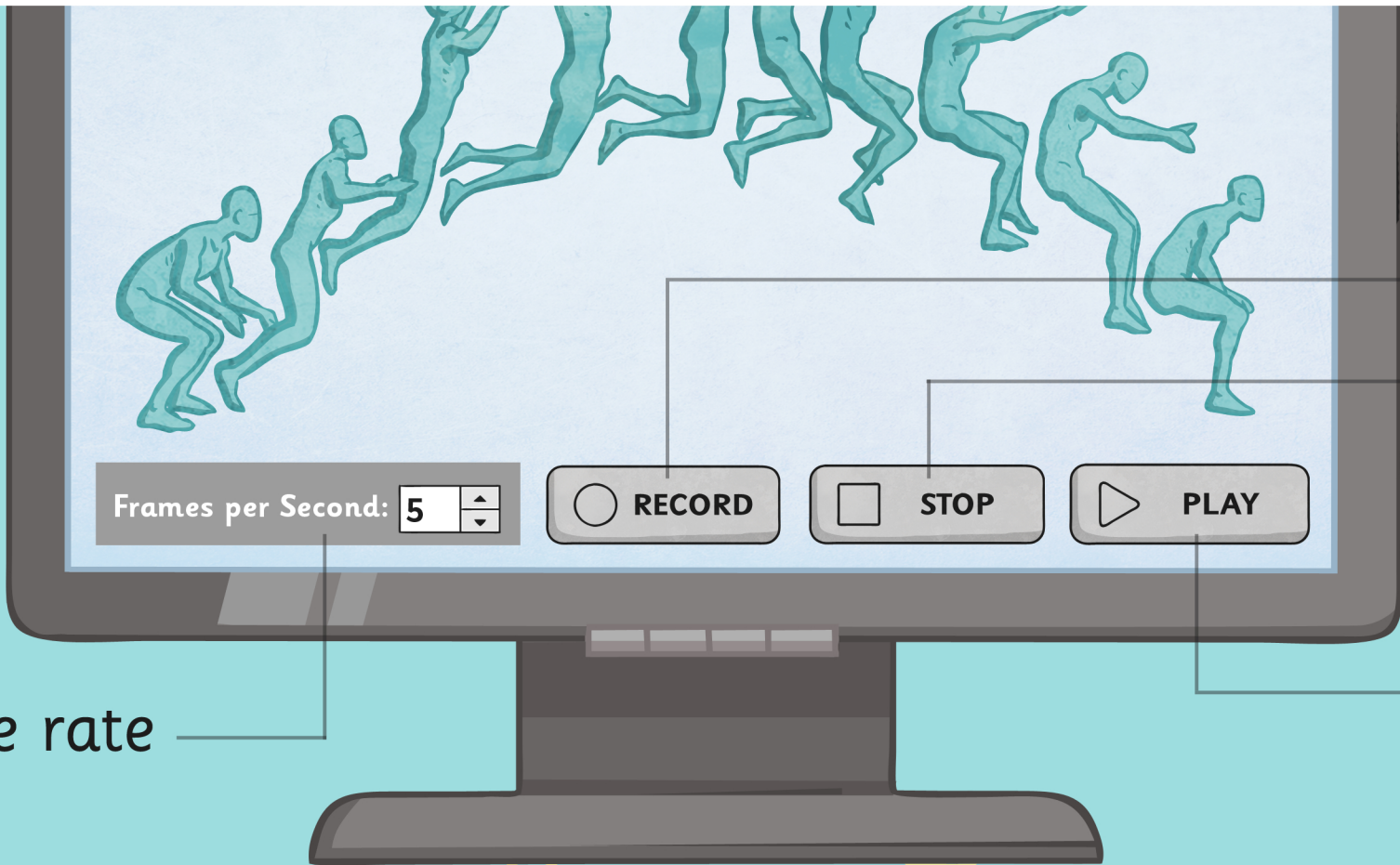

record

stop

play

frame rate



Animation

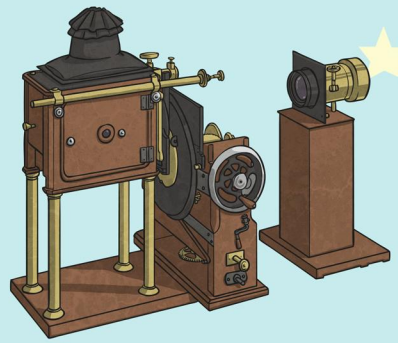

zoopraxiscope



zoetrope

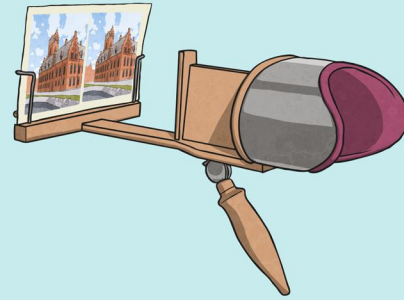

stereoscope



flip book

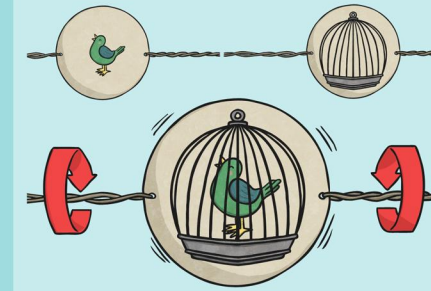

thaumatrope

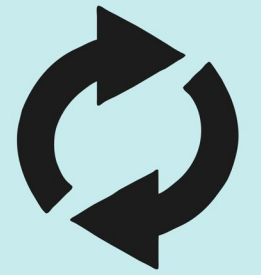

loop

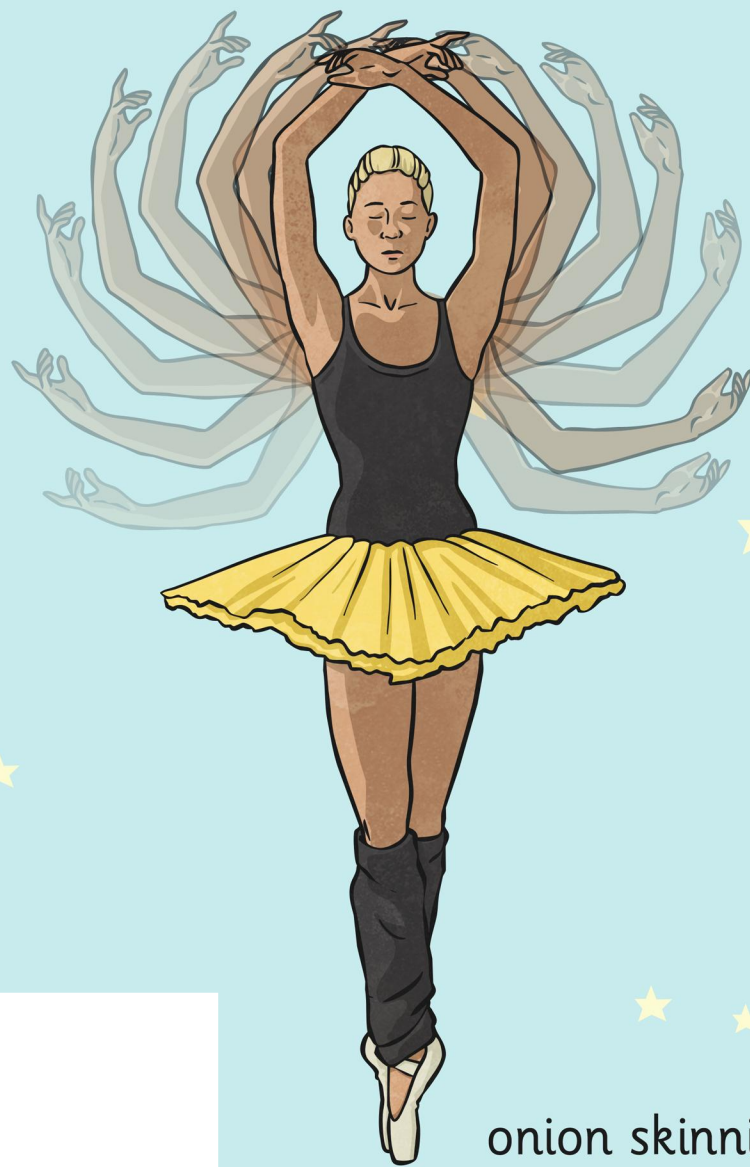

onion skinning



still image



stick man

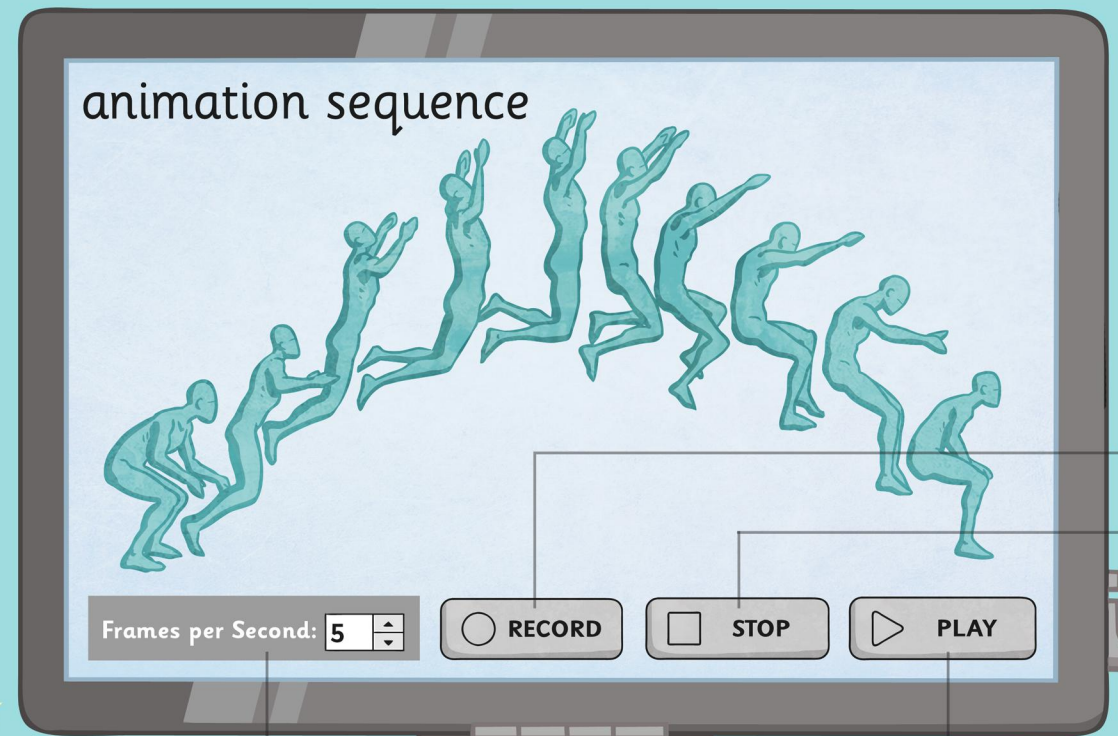

frame rate

record
stop

play

Animation

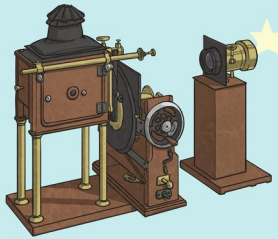

zoopraxiscope



zoetrope

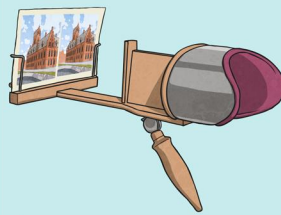

stereoscope



flip book

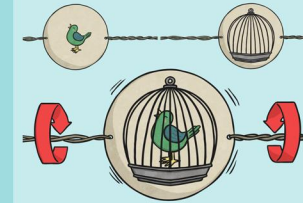

thaumatrope

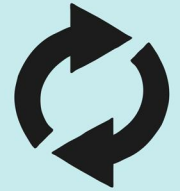

loop

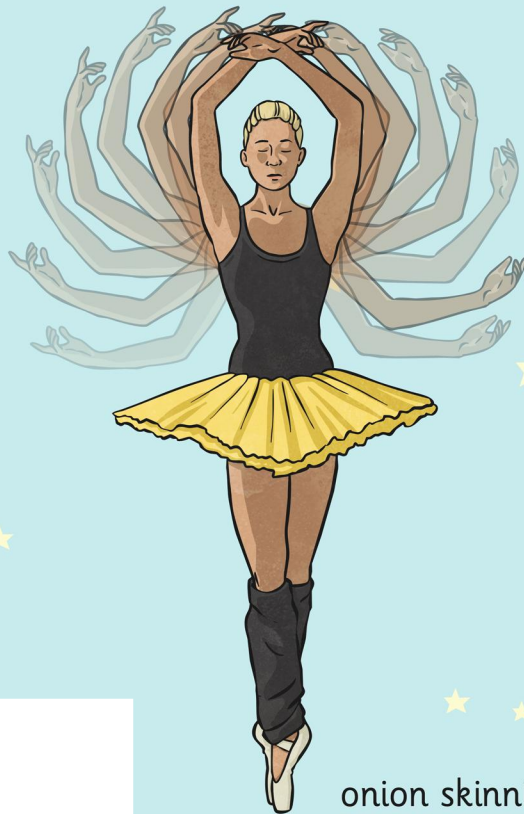

onion skinning



still image



stick man

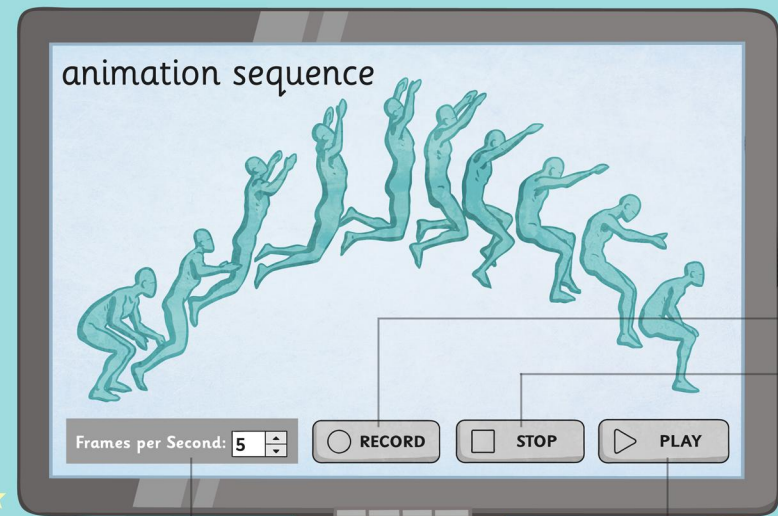

animation sequence

Frames per Second: 5

RECORD

STOP

PLAY

record
stop

play

frame rate

frame rate

Frames per Second:

5

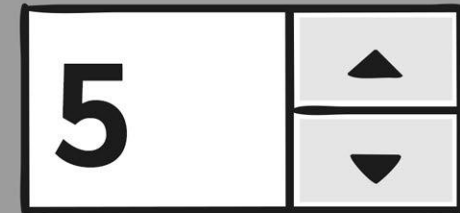

play



stop



record



thaumantope

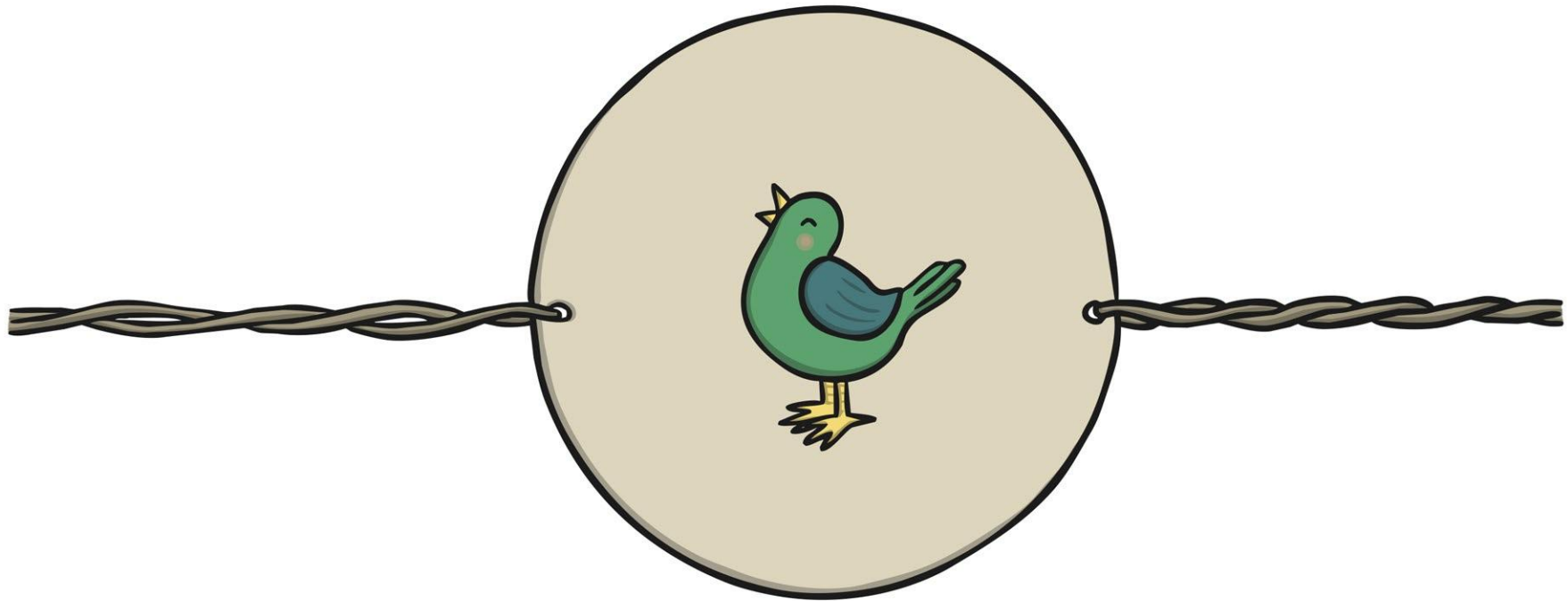

onion skinning



Regent Studies | www.regentstudies.com

zoetrope



Regent Studies | www.regentstudies.com

flip book



animation



zoopraxiscope

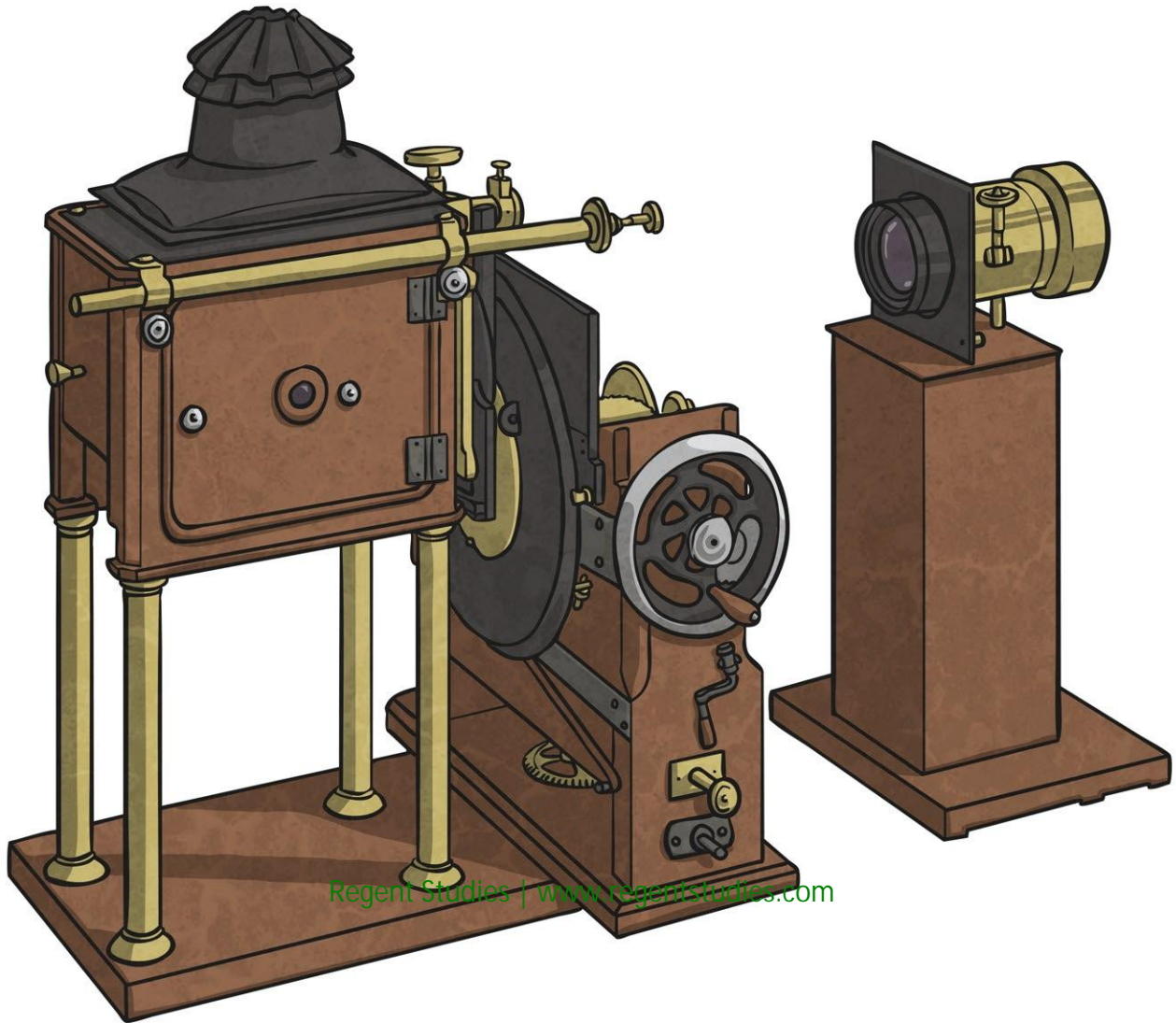

stereoscope

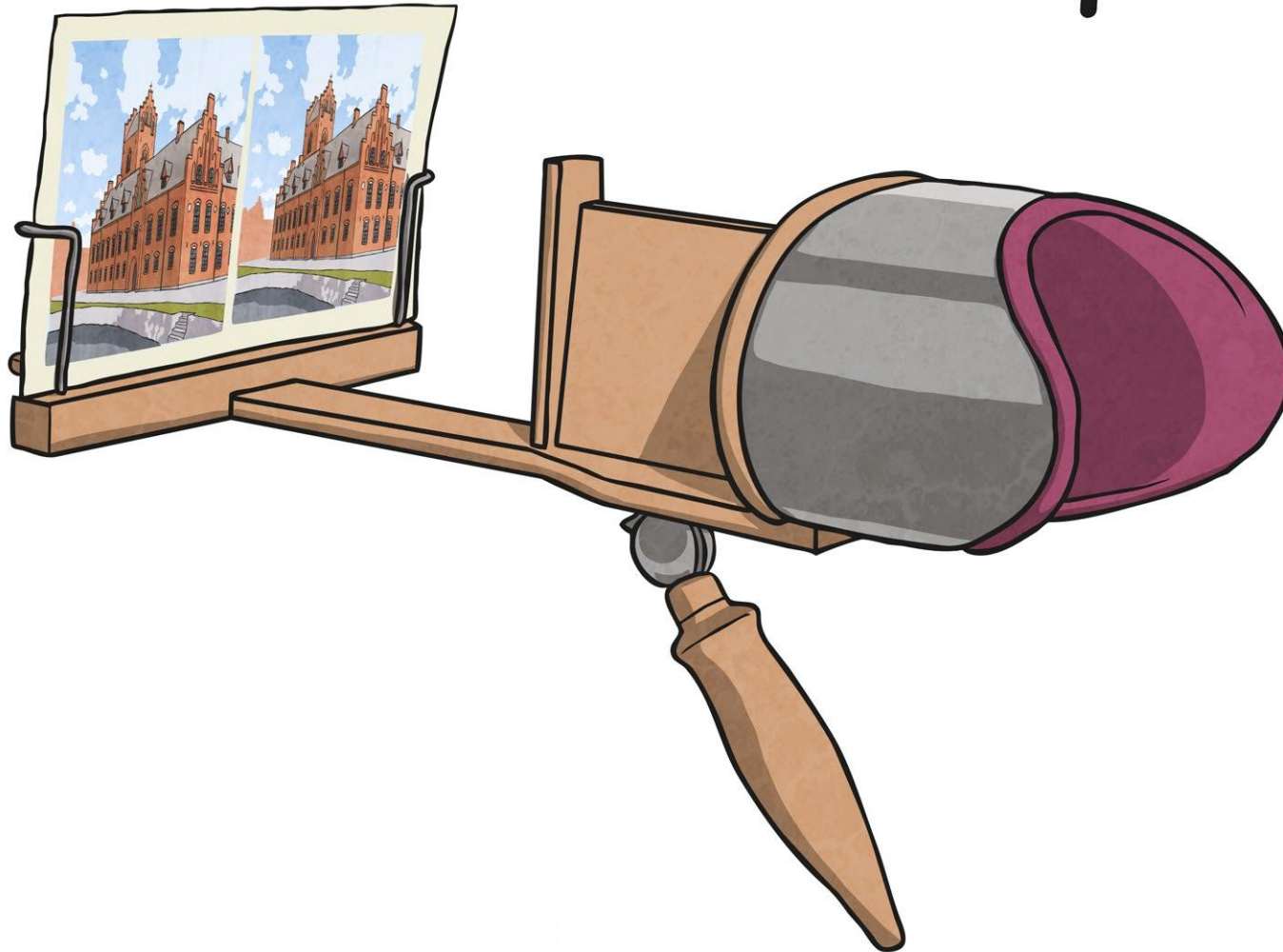

loop



Regent Studies | www.regentstudies.com

still image

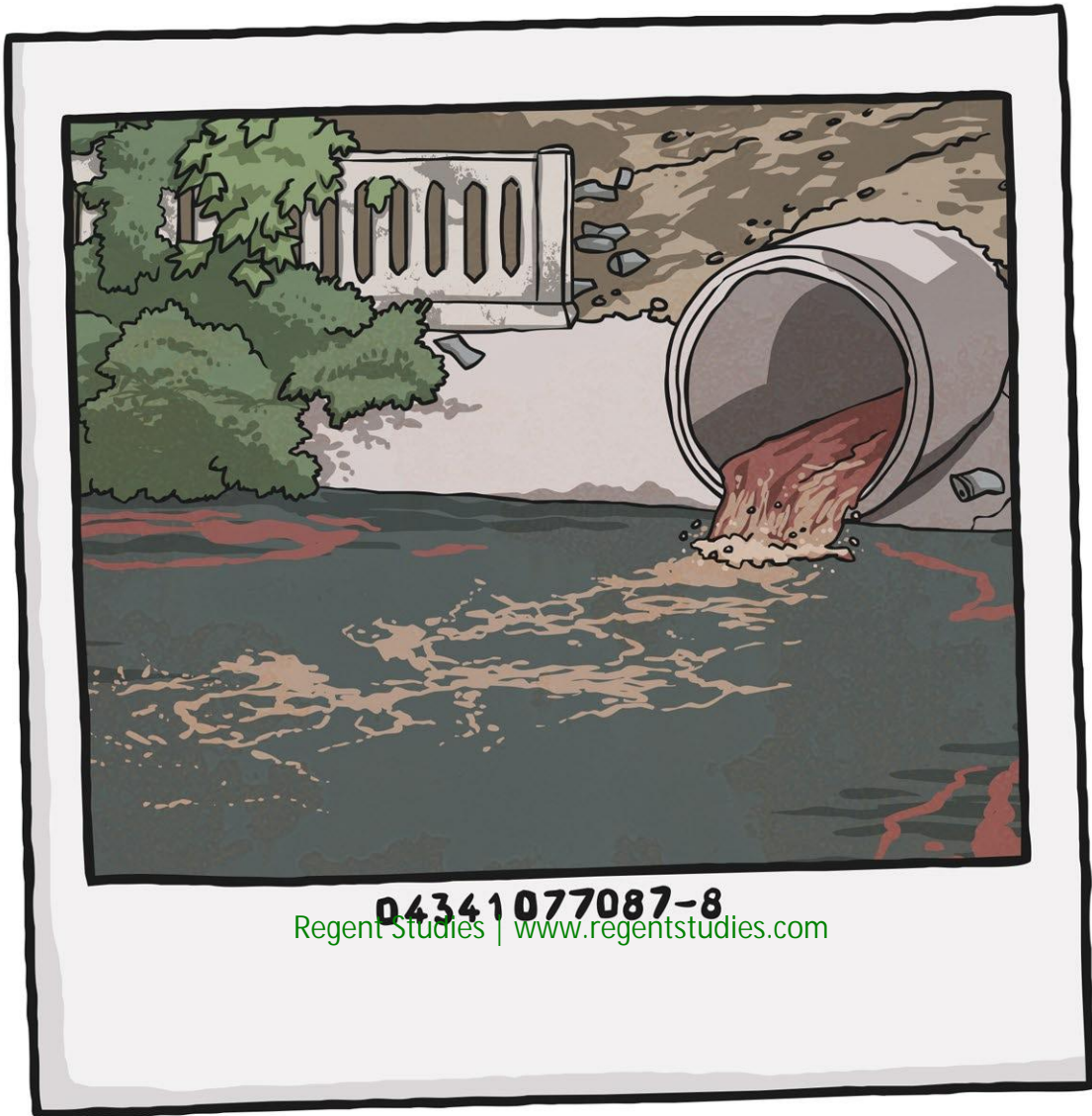

04341077087-8
Regent Studies | www.regentstudies.com

evaluate



Regent Studies | www.regentstudies.com

stop motion



Regent Studies | www.regentstudies.com

frame rate

Frames per Second:

5

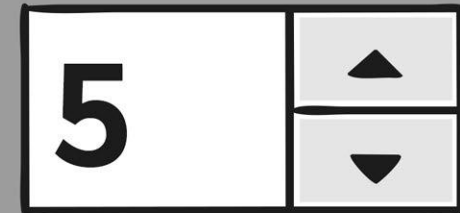

play



stop



record



thaumantrope

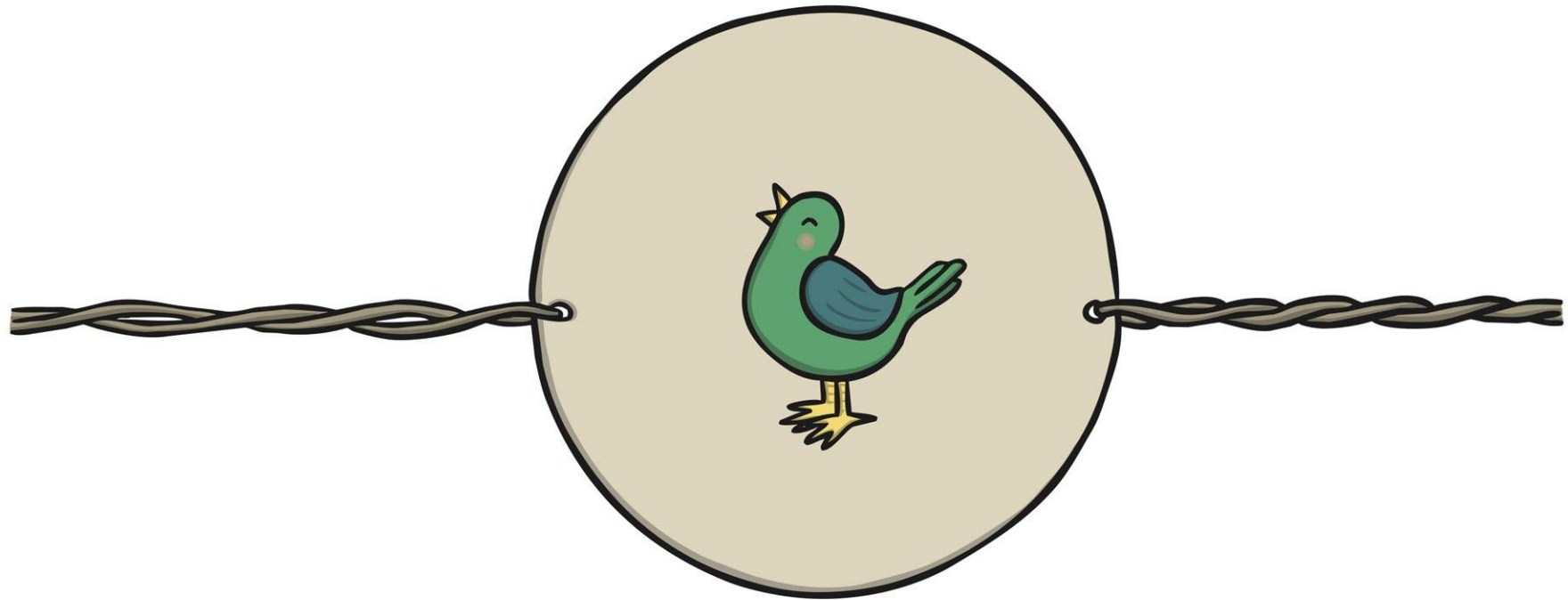

onion skinning



Regent Studies | www.regentstudies.com

zoetrope



flip book



animation



zoopraxiscope

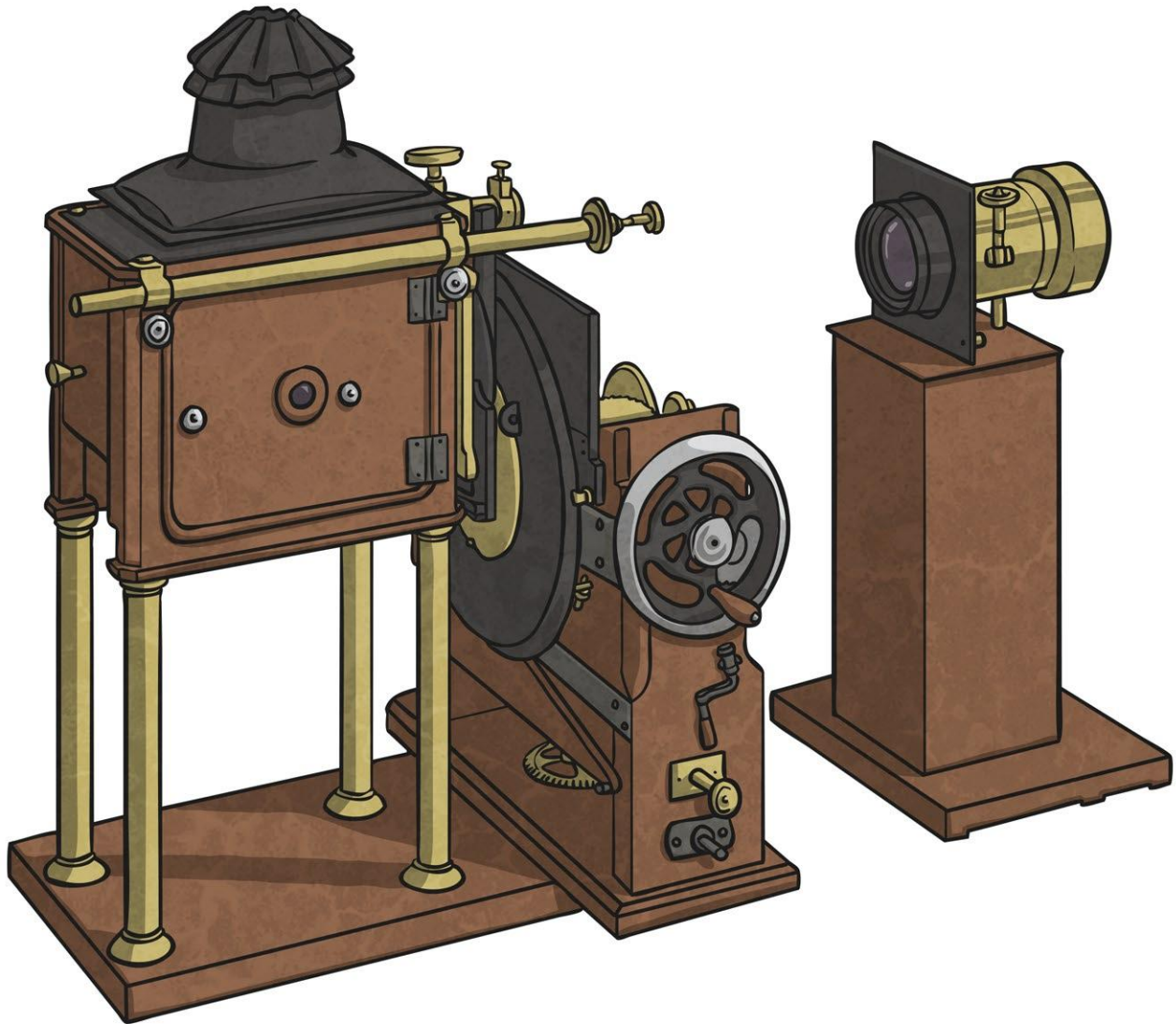

stereoscope

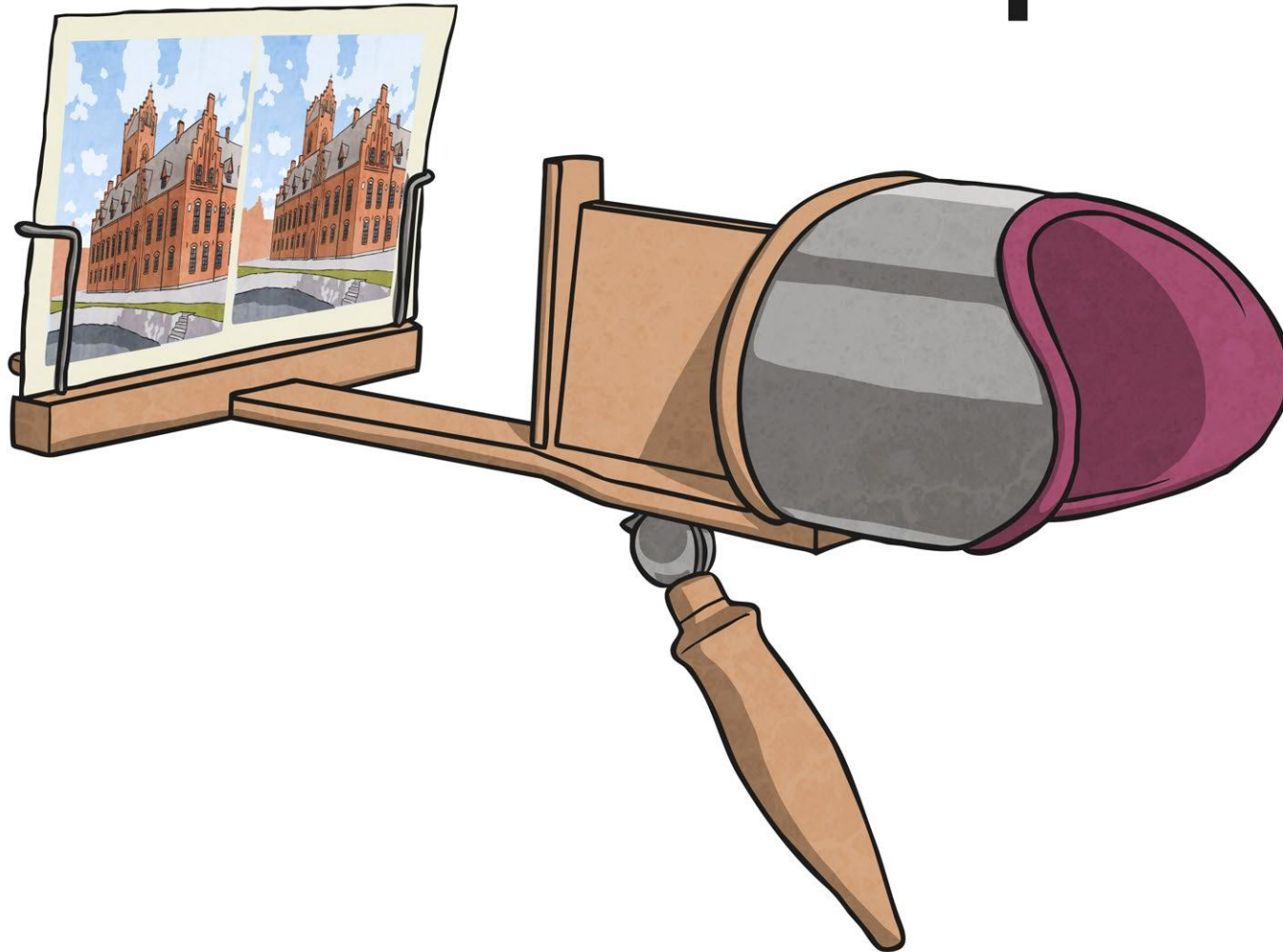

loop

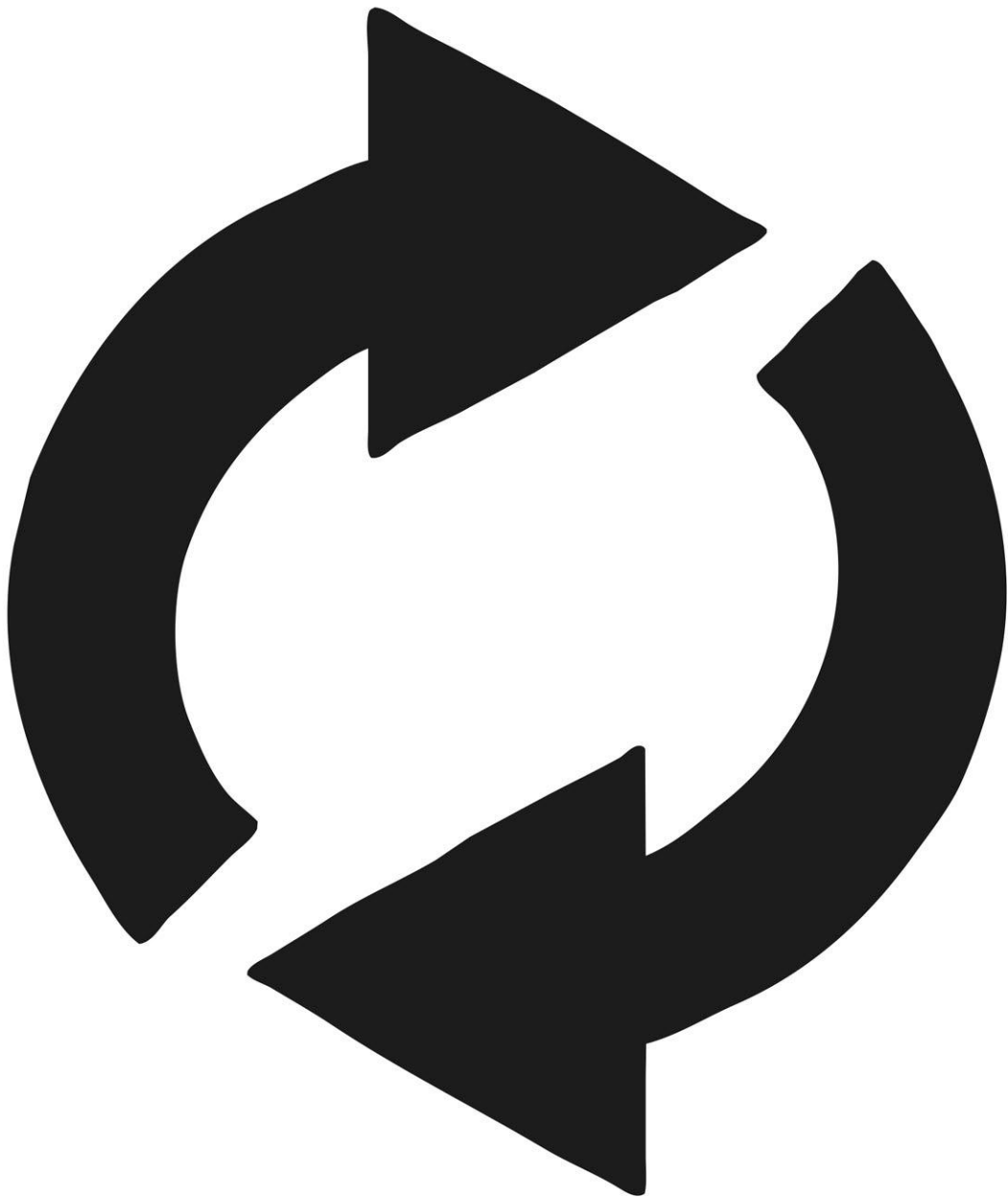

still image



evaluate



Regent Studies | www.regentstudies.com

stop motion



Regent Studies | www.regentstudies.com

Insert text here

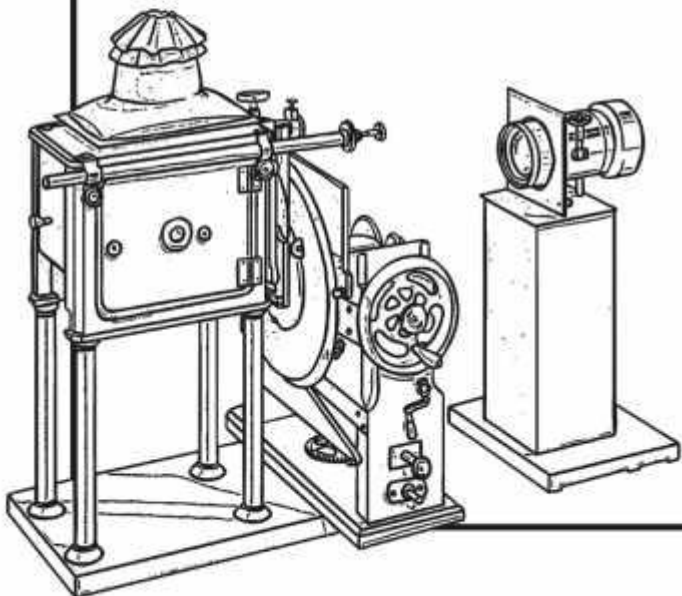

Insert text here

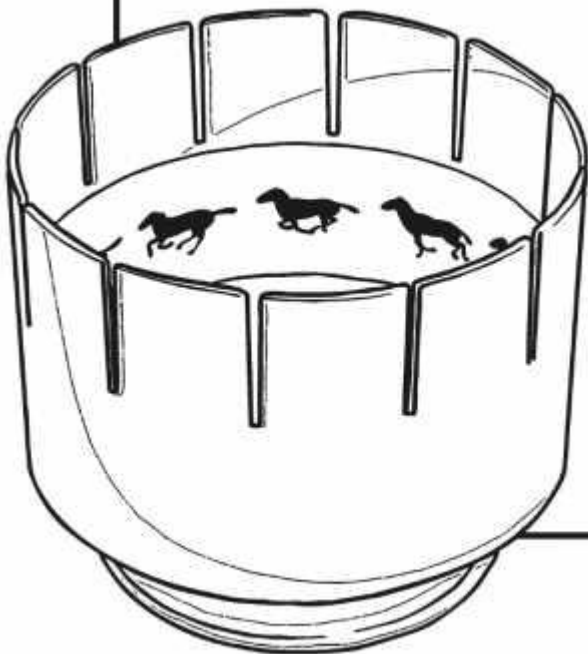

Insert text here

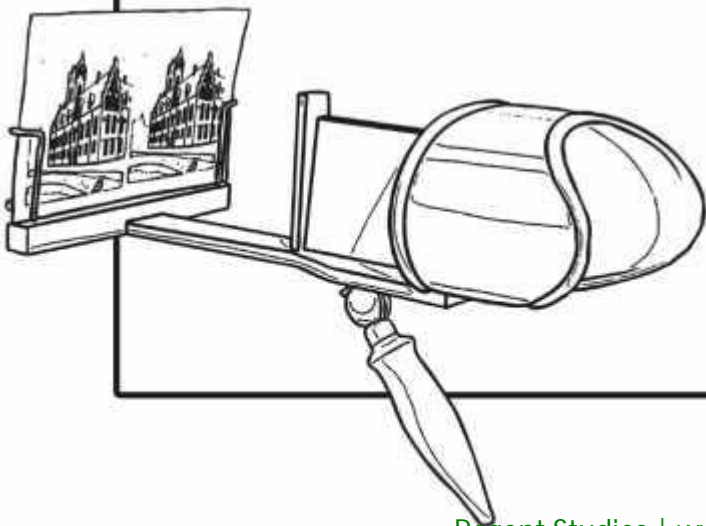

Insert text here



Insert text here



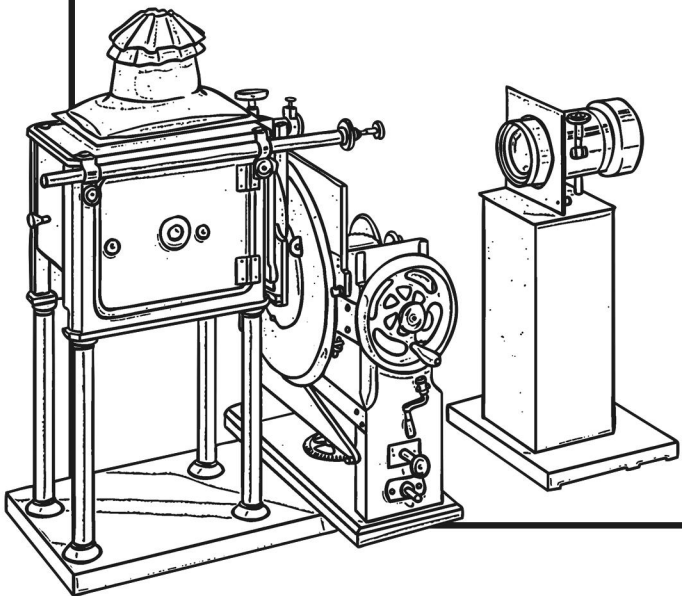

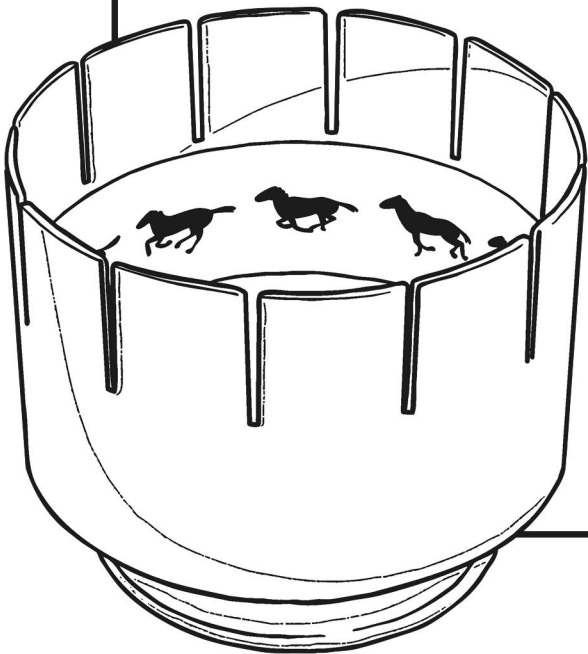

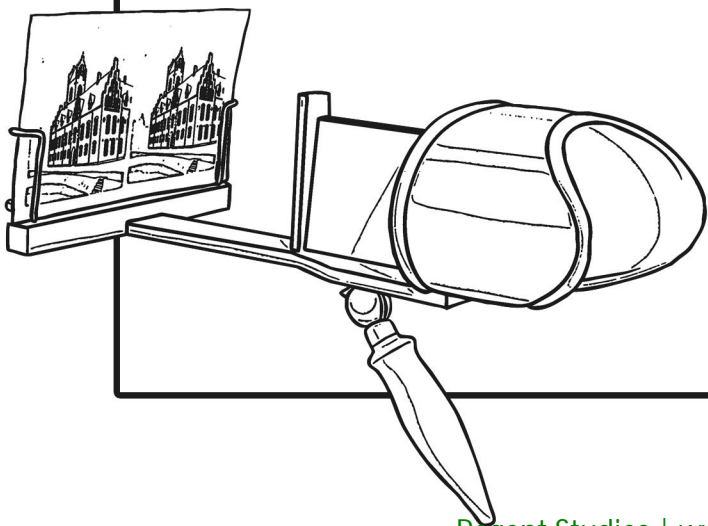



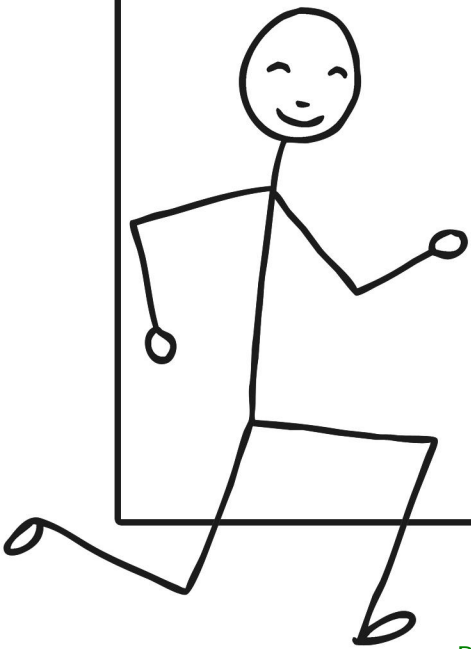

Insert text here

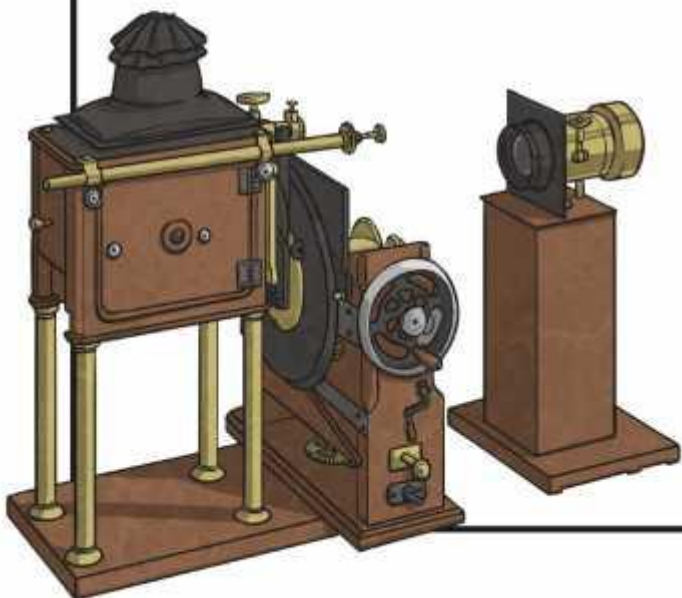

Insert text here



Insert text here

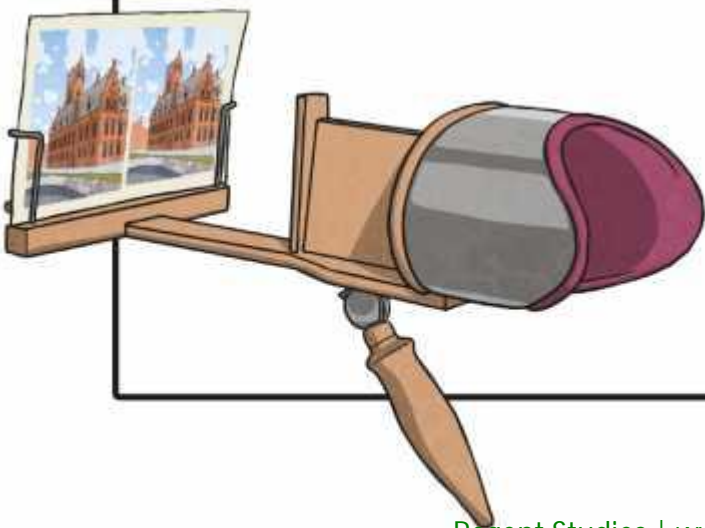

Insert text here



Insert text here



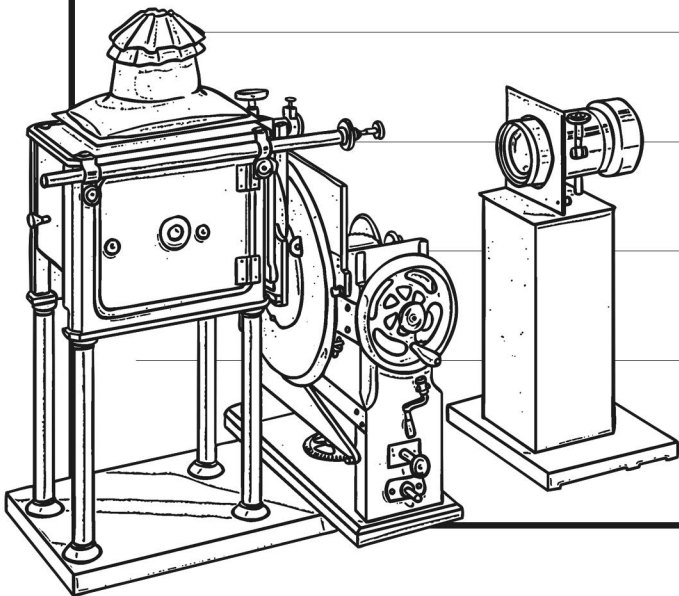

A large rectangular frame containing a writing area with horizontal lines. The lines are spaced evenly and extend across most of the width of the frame. The bottom of the frame is partially obscured by the drawing of a horse race track.

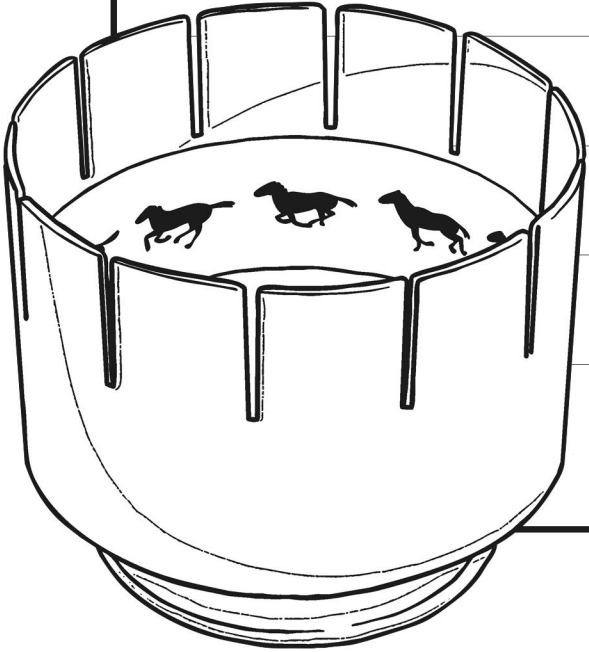

A large rectangular frame containing a writing area with four horizontal lines. Below the lines, there is a line drawing of a desk setup including a book with a building illustration, a magnifying glass, and a quill pen.

A large rectangular frame containing a series of horizontal lines for writing, positioned in the upper and middle sections of the page.



A large rectangular frame containing a series of horizontal lines for writing. The lines are spaced evenly and extend across most of the width of the frame.

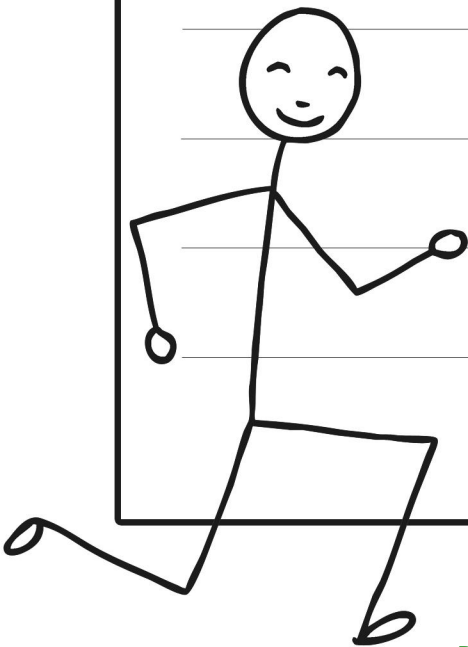

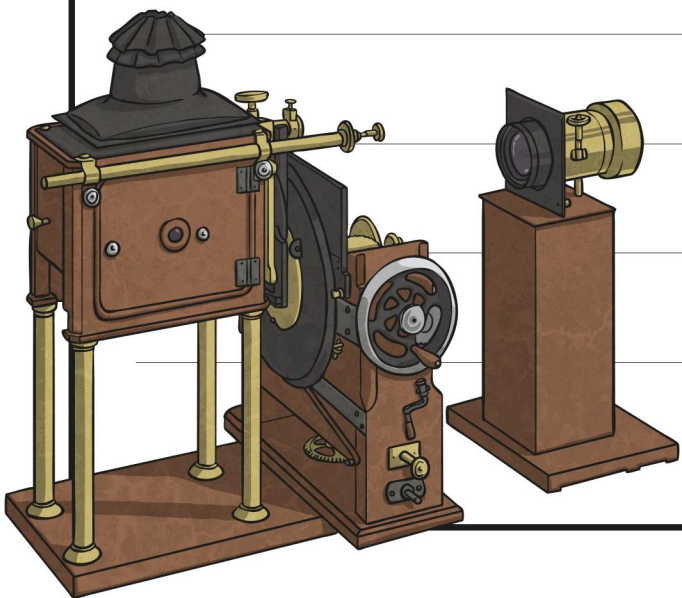

A large rectangular frame containing a writing area with horizontal lines. The lines are spaced evenly and extend across most of the width of the frame.



A large rectangular frame containing a blank white space for drawing or writing. At the bottom of the frame, there are four horizontal lines for writing. Below the frame, there is an illustration of an artist's palette and a paintbrush.

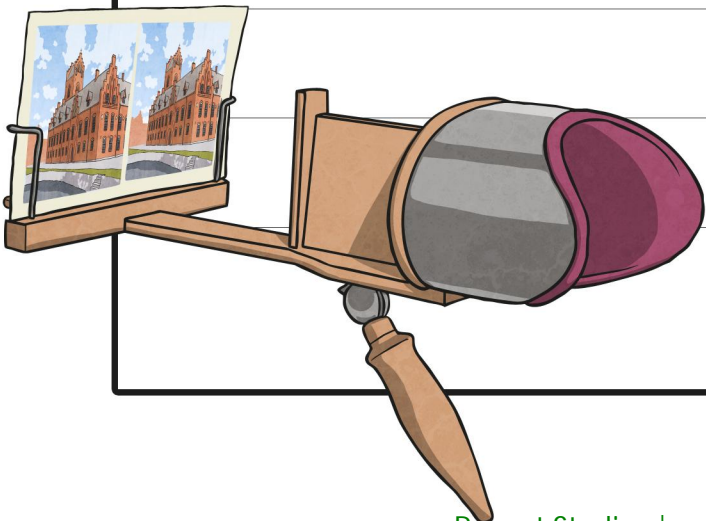

A large rectangular frame containing four horizontal lines for writing.



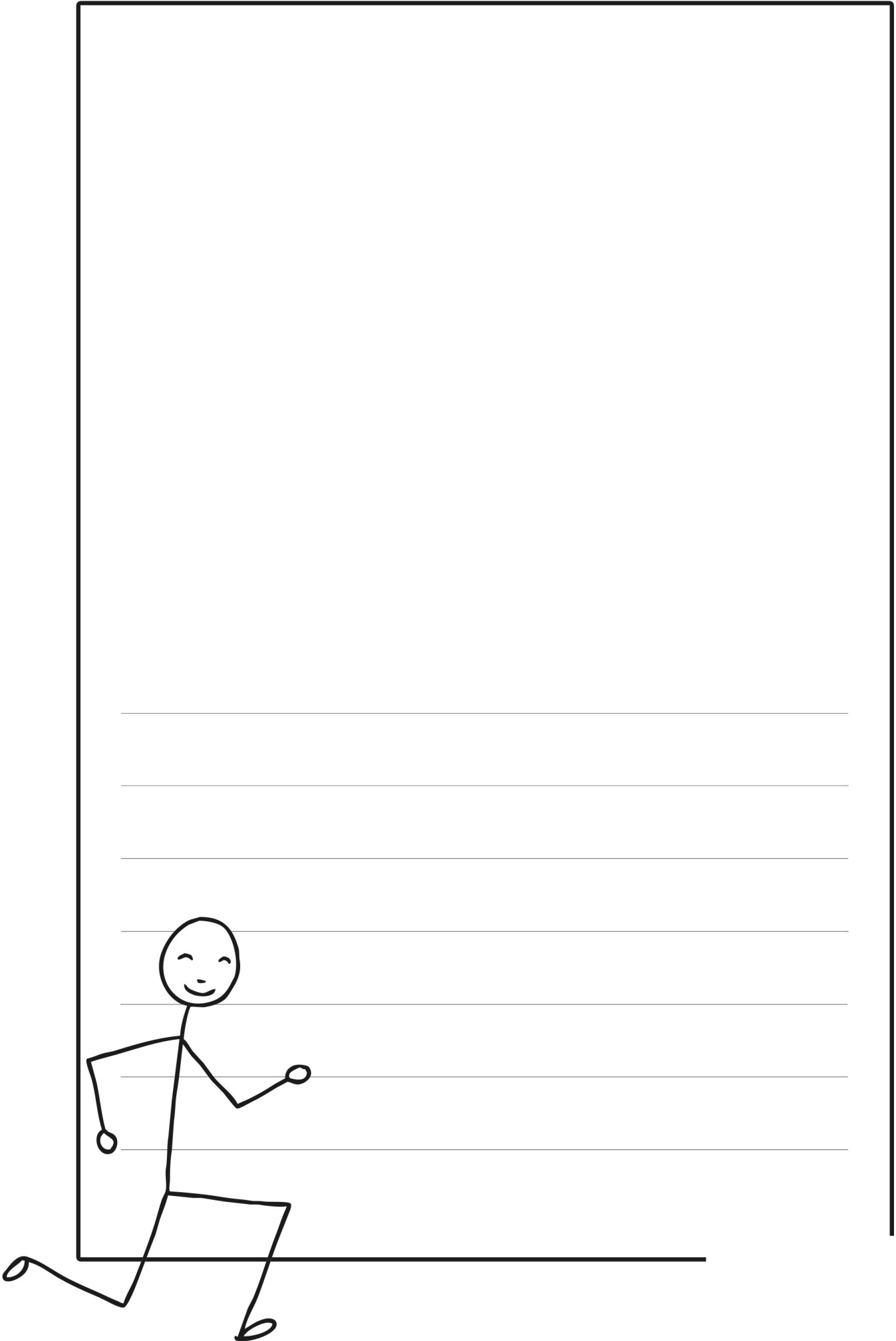

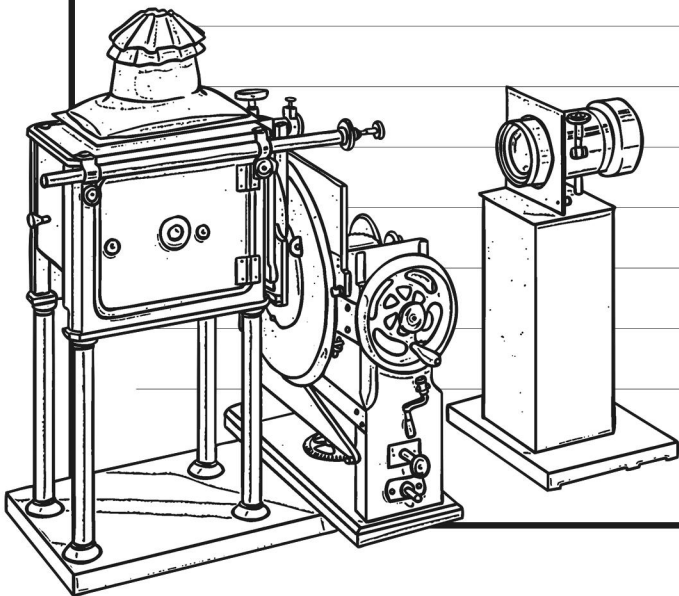

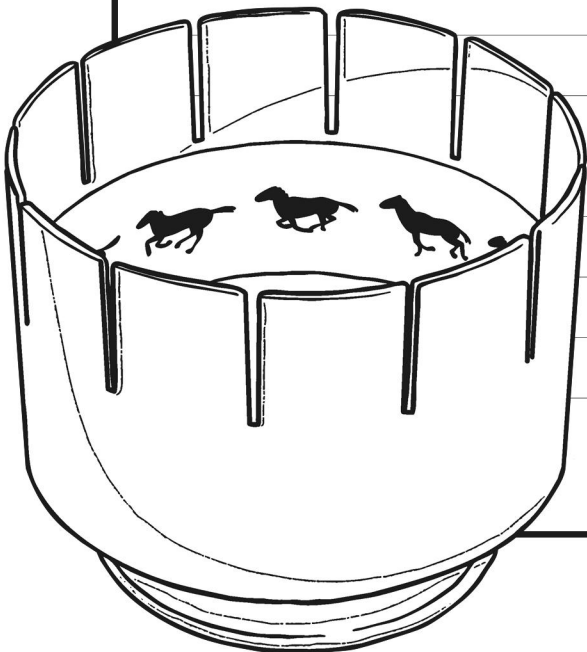

A large rectangular frame containing a series of horizontal lines for writing, positioned in the lower half of the page.

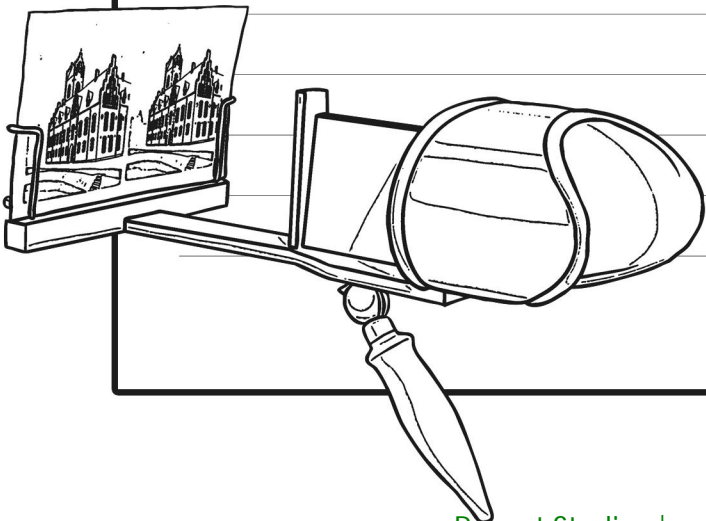

A large rectangular frame containing ten horizontal lines for writing.



A large rectangular frame containing a series of horizontal lines for writing, with a stick figure character at the bottom left.

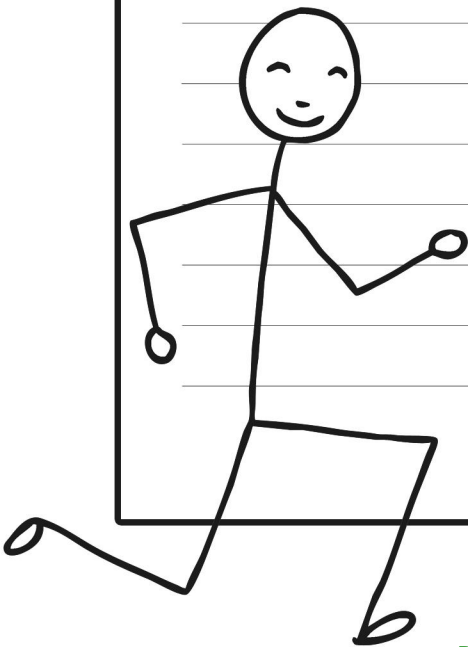

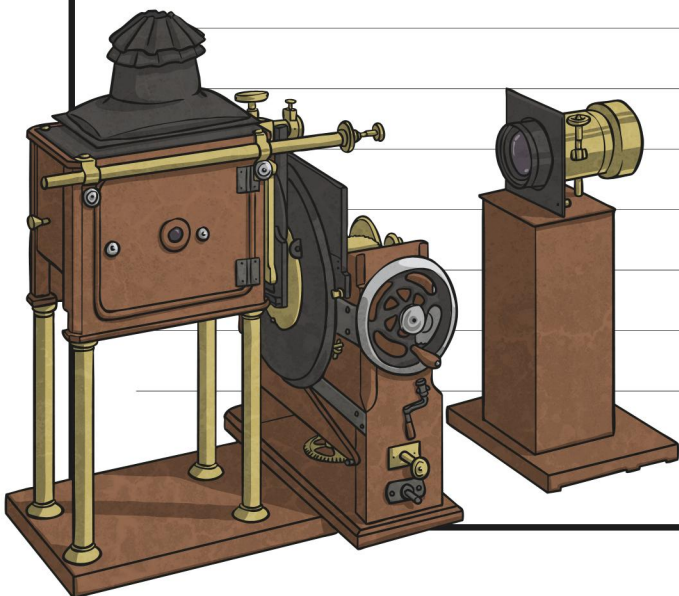

A large rectangular frame containing a series of horizontal lines for writing, positioned in the upper and middle sections of the page.



A large rectangular frame containing a blank white space at the top and seven horizontal lines for writing at the bottom.

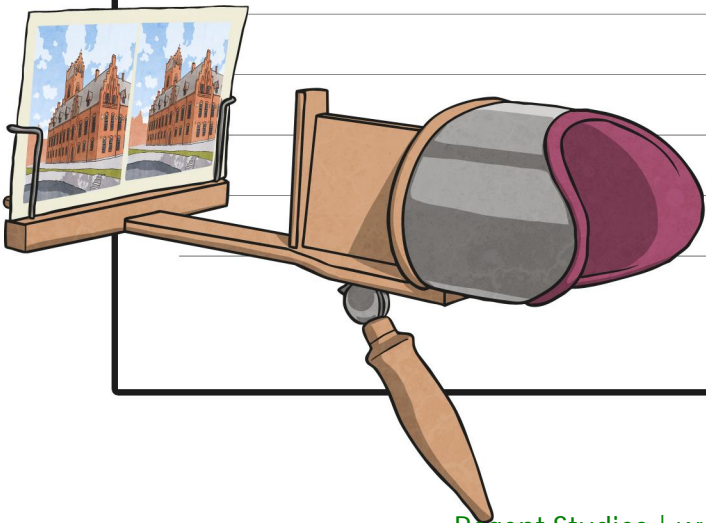

A large rectangular frame containing ten horizontal lines for writing.



A large rectangular frame containing a series of horizontal lines for writing. The lines are evenly spaced and extend across most of the width of the frame. The top portion of the frame is empty, while the bottom portion contains the lines and a stick figure.

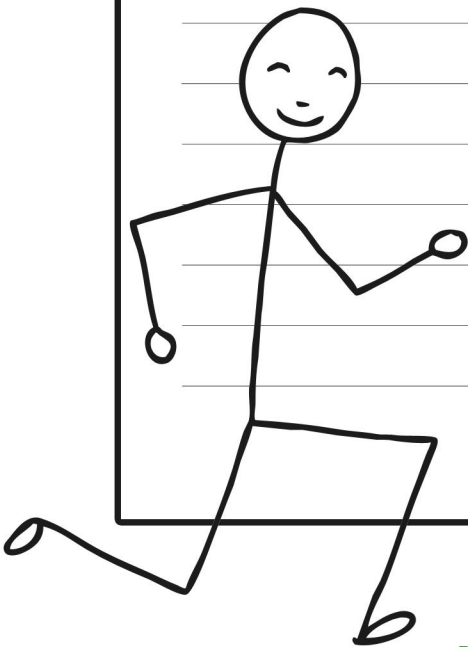

A large rectangular area with horizontal lines for writing, intended for notes or answers related to the diagram.

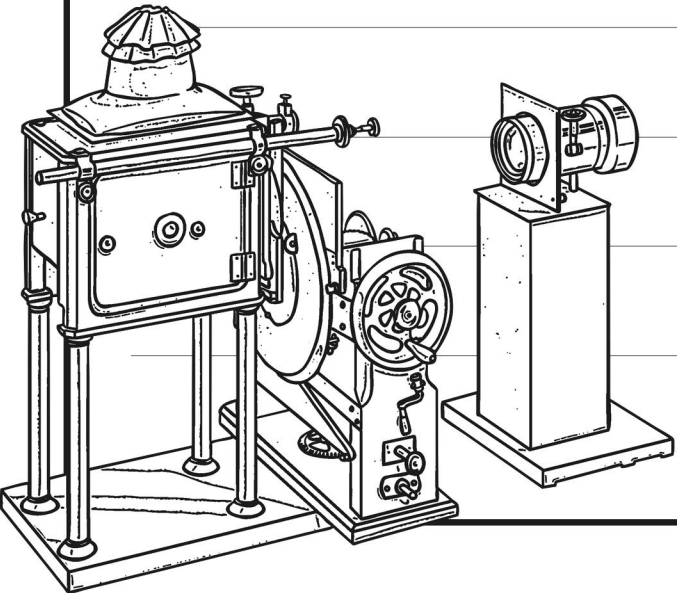

A large rectangular area with a black border, containing 15 horizontal lines for writing.

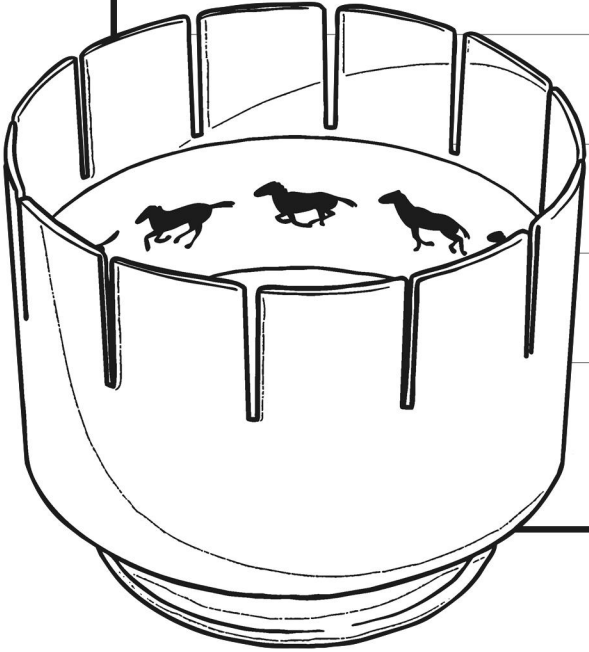

A large rectangular frame containing 20 horizontal lines for writing.

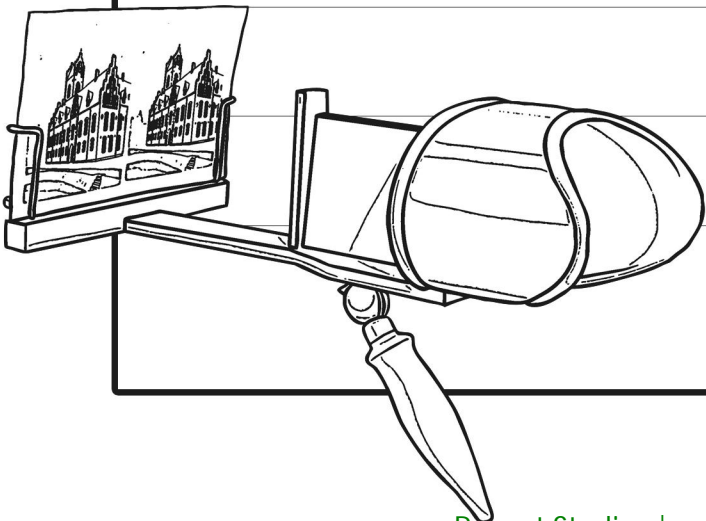

Lined writing area with 15 horizontal lines.



A large rectangular frame containing 20 horizontal lines for writing.

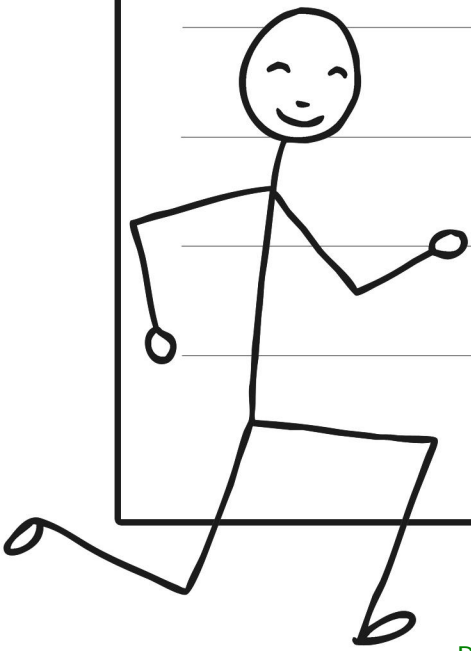

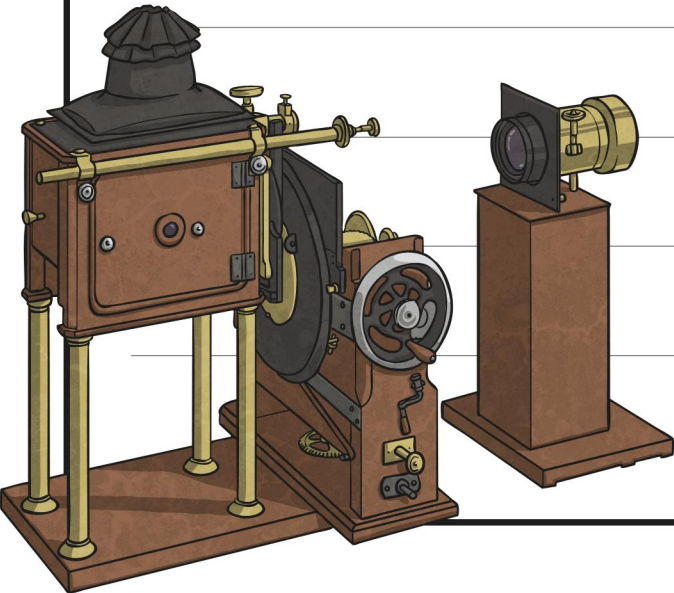

A large rectangular frame containing 15 horizontal lines for writing.



A large rectangular frame containing 18 horizontal lines for writing.

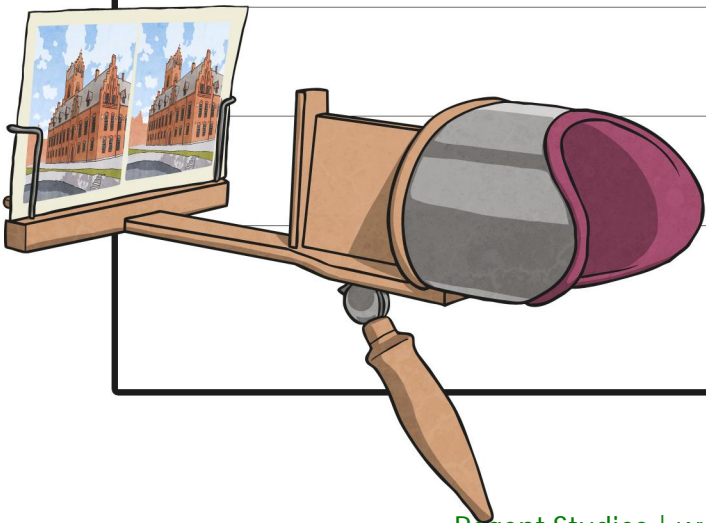



A large rectangular frame containing 20 horizontal lines for writing.

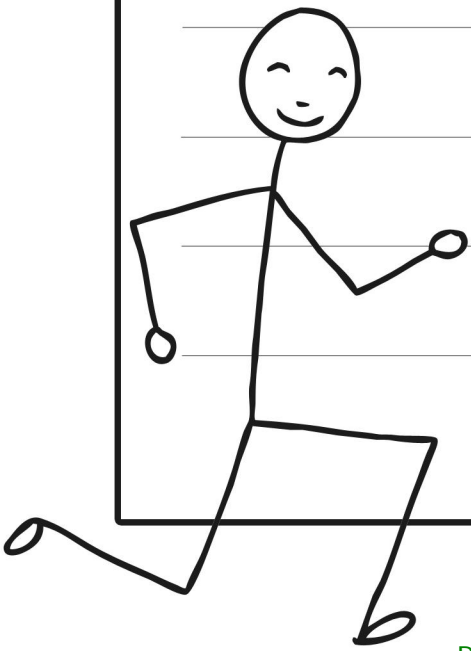

A large rectangular area with horizontal lines, intended for writing or drawing.

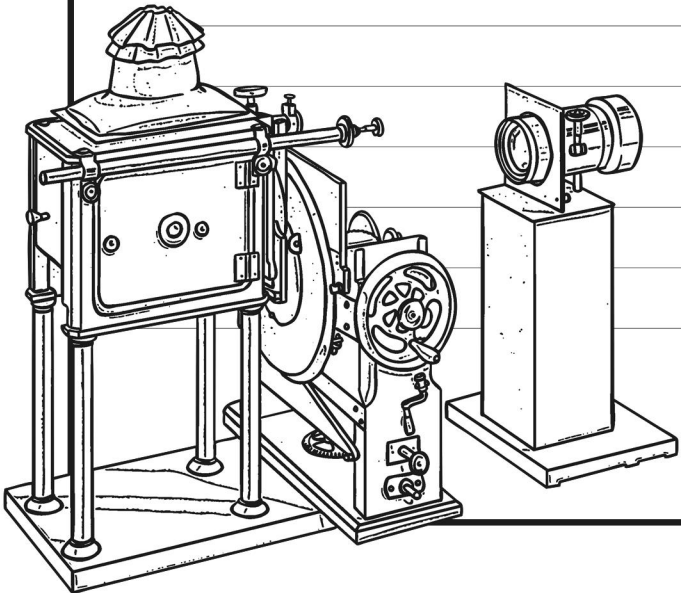

A large rectangular frame containing 25 horizontal lines for writing.

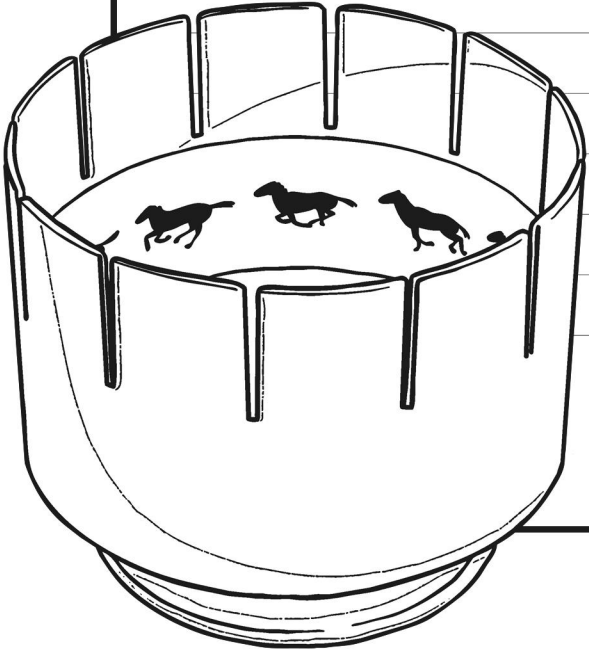

A large rectangular frame containing 25 horizontal lines for writing.

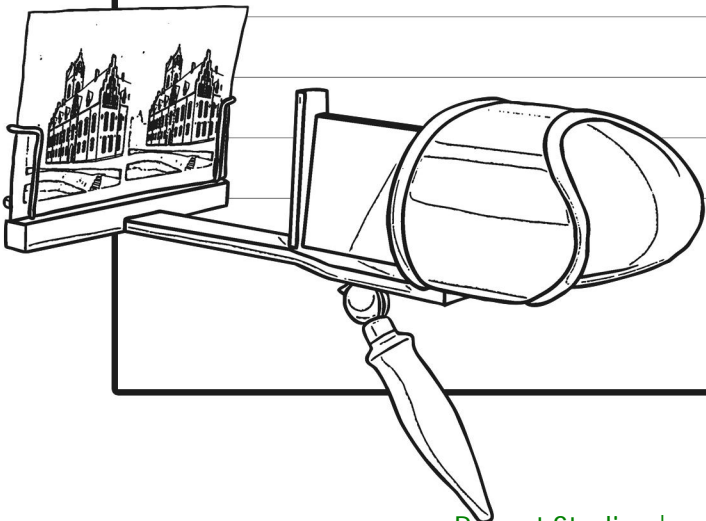

Lined writing area for notes.



A large rectangular frame containing 25 horizontal lines for writing.

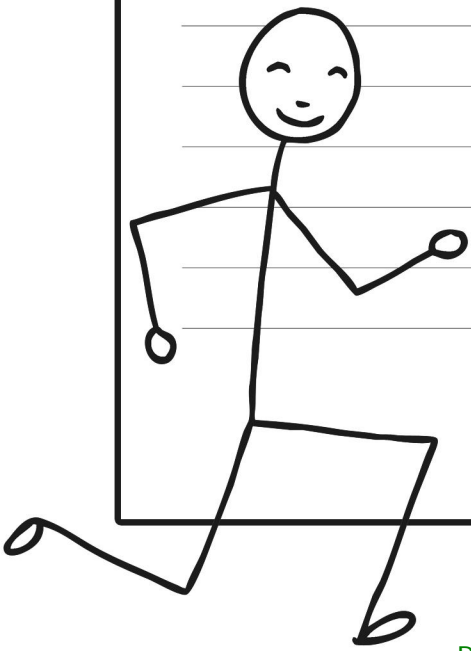

A large rectangular area with a black border, containing 20 horizontal lines for writing.

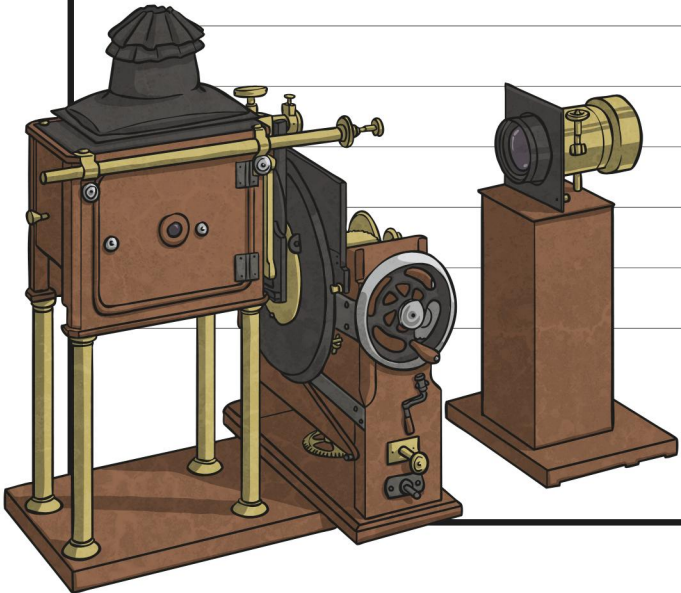

A large rectangular frame containing 25 horizontal lines for writing.



A large rectangular frame containing 20 horizontal lines for writing.

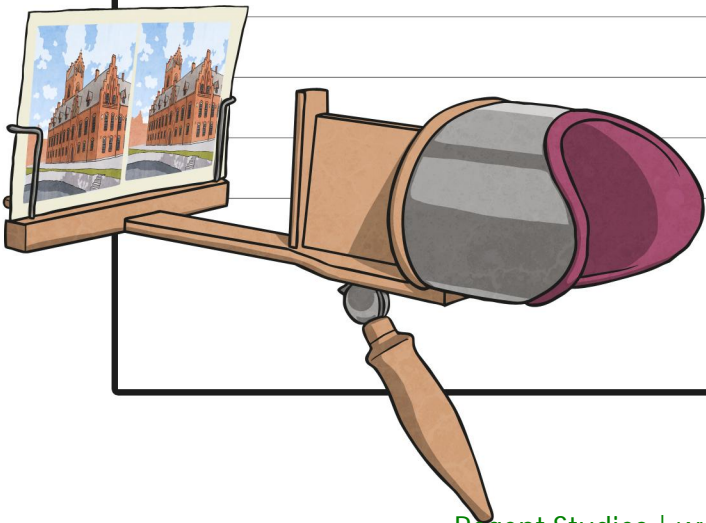

A large rectangular frame containing 25 horizontal lines for writing.



Lined writing area with 20 horizontal lines.

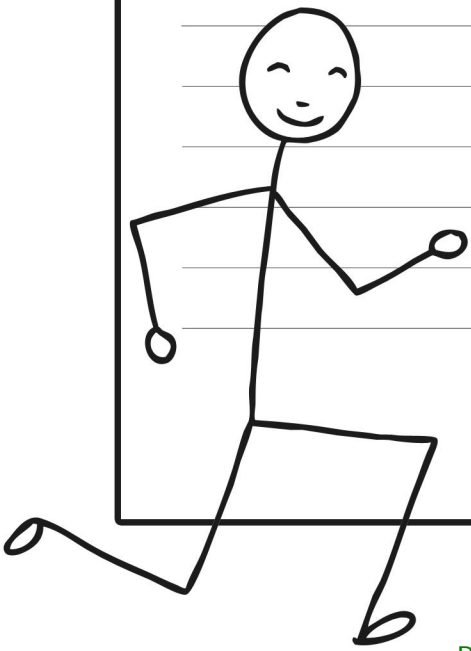

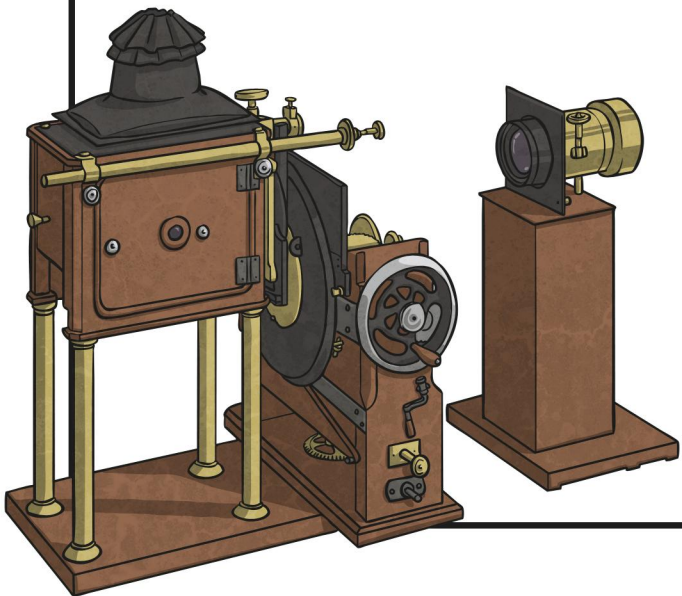

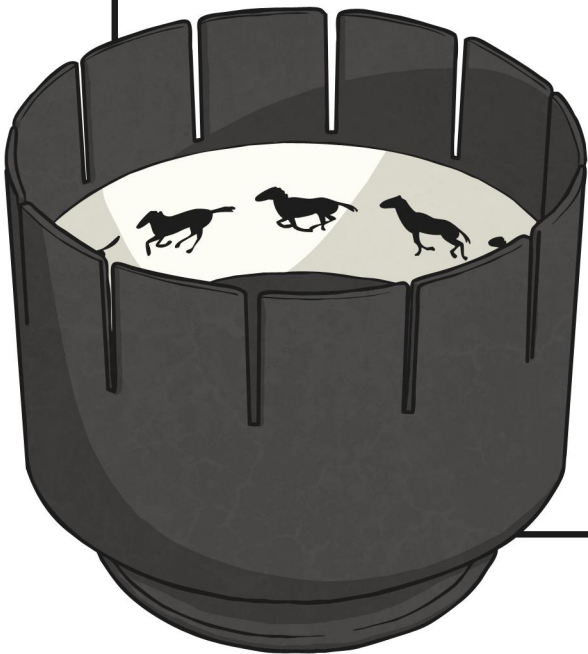

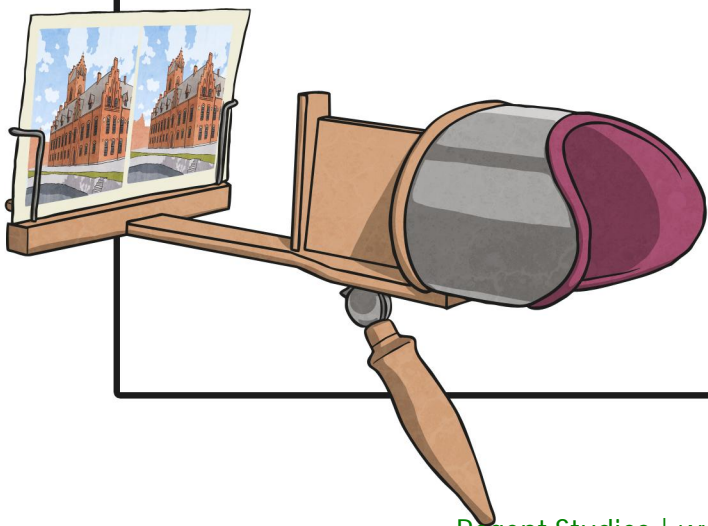



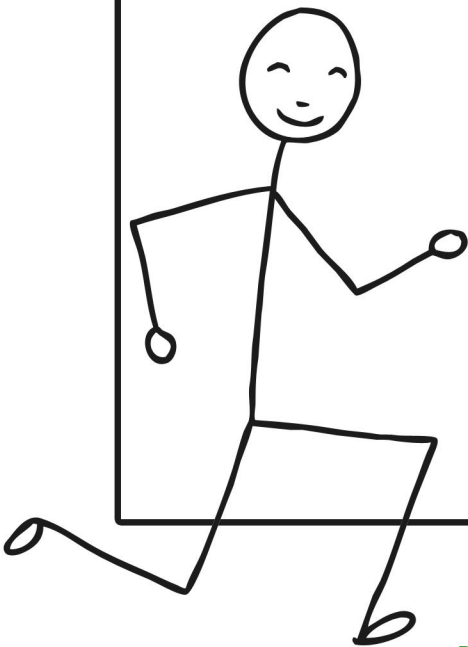

frame rate

Frames per Second:

play



stop



record



onion skinning



thaumatrope

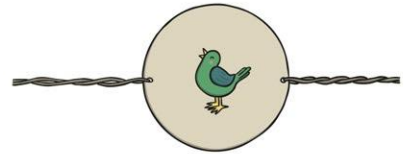

zoetrope



animate

flip book



animation

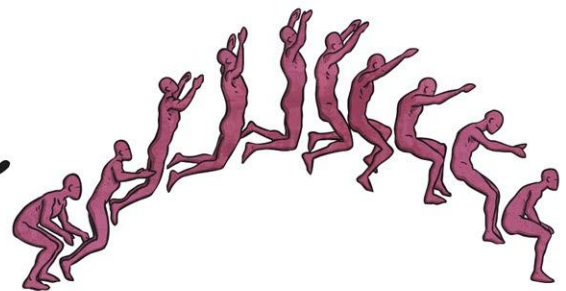

zoopraxiscope

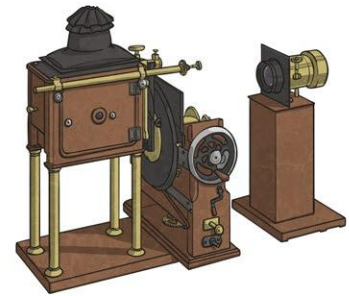

frame

stereoscope

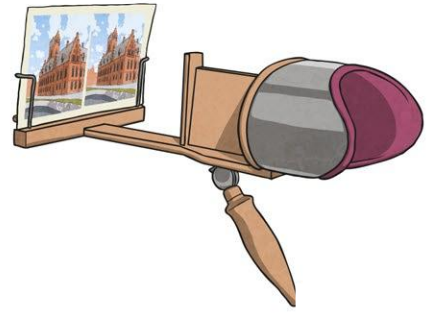

loop

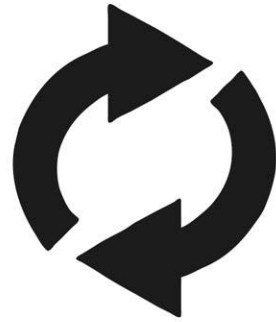

still image



backdrop

analyse

evaluate



stop motion



frame rate

Frames per Second:

play



stop



record



onion skinning



thaumatrope

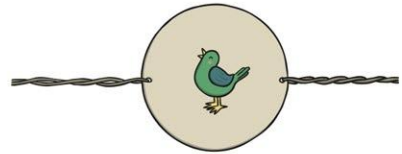

zoetrope



animate

flip book



animation

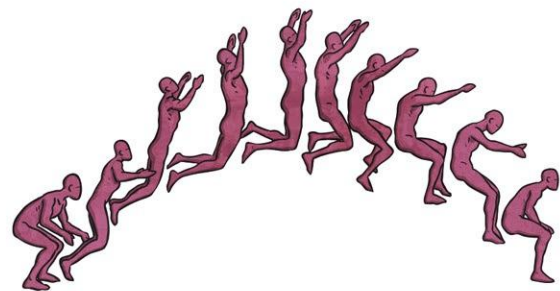

zoopraxiscope

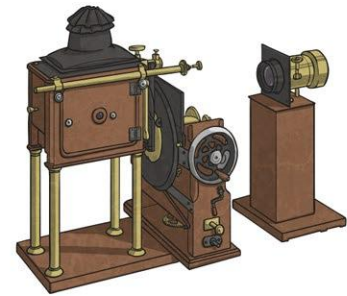

frame

stereoscope

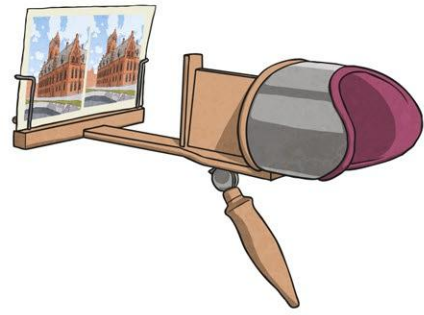

loop

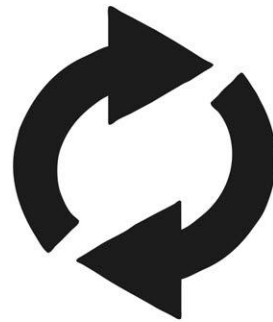

still image



backdrop

analyse

evaluate



stop motion



Animation

Frames per Second: 5



PLAY

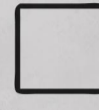

STOP



RECORD

frame rate

play

stop

record



onion skinning

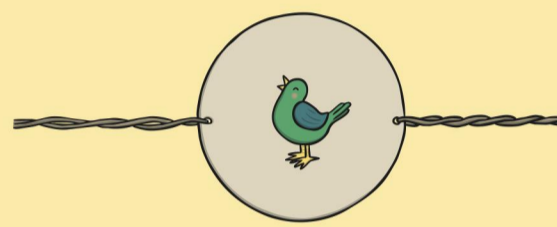

thaumatrope



zoetrope



flip book

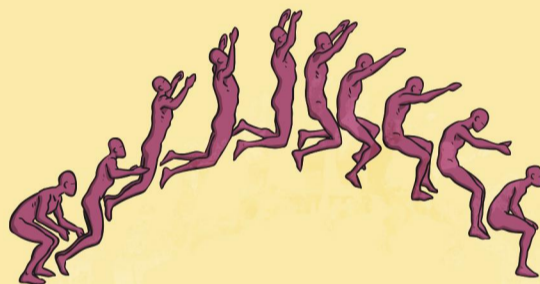

animation

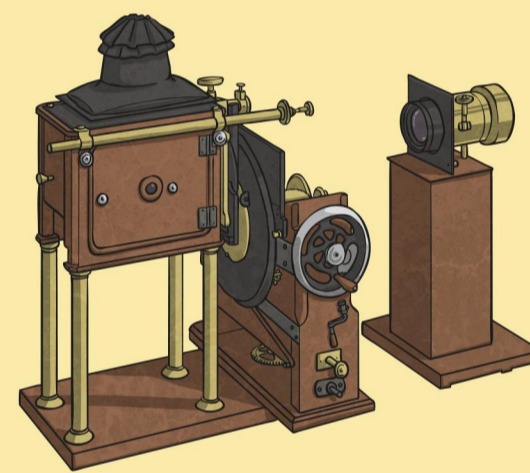

zoopraxiscope

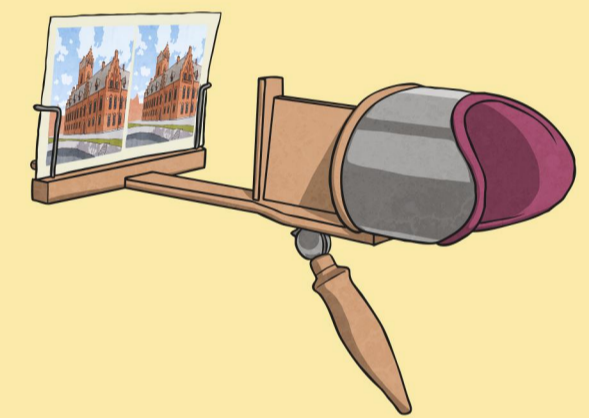

stereoscope

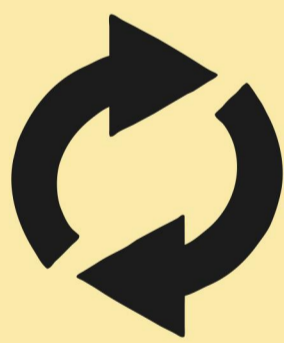

loop



still image



stop motion

Animation Analysis

- Are the backgrounds colourful?
- Do the drawings look like they're moving?
- Does it have 5 frames per second?
- Would it look better in stop motion?
- Does the onion skinning look good?
- Am I happy with the end result?
- Did we work well as a team?
- Did I enjoy making my animation?

analyse



evaluate

Animation

Frames per Second:



frame rate

play

stop

record

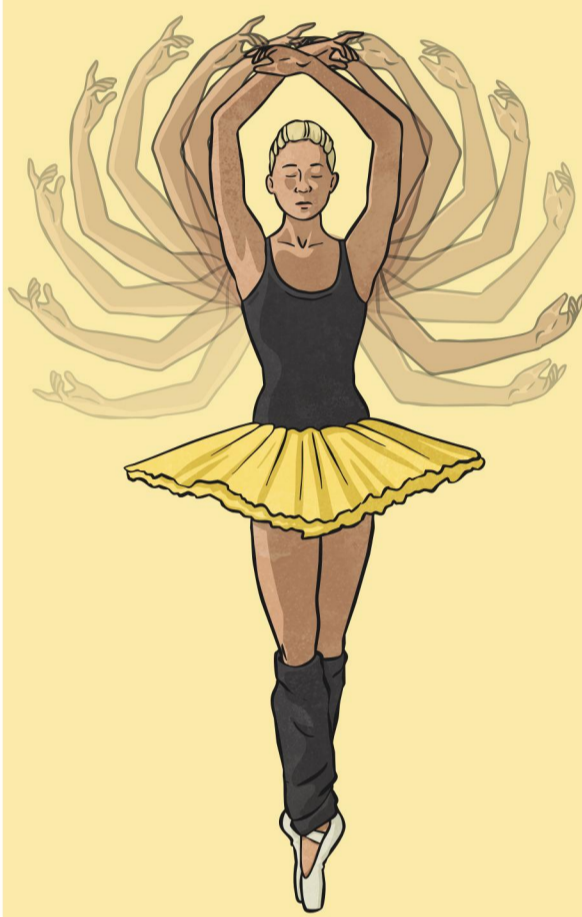

onion skinning

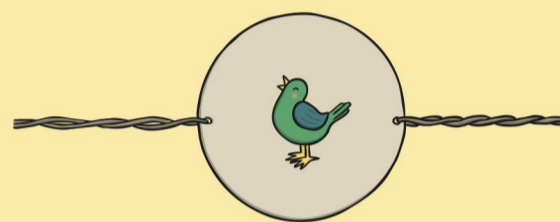

thaumatrope



zoetrope



flip book



animation

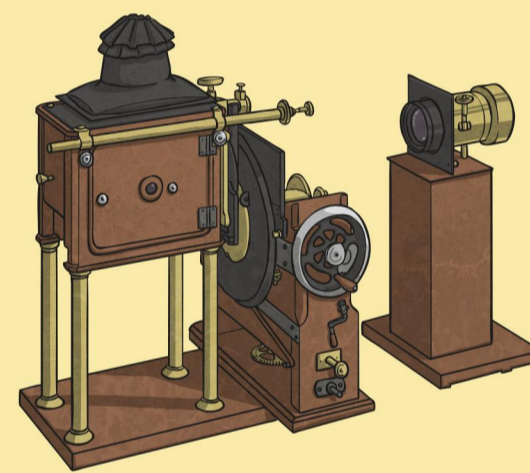

zoopraxiscope

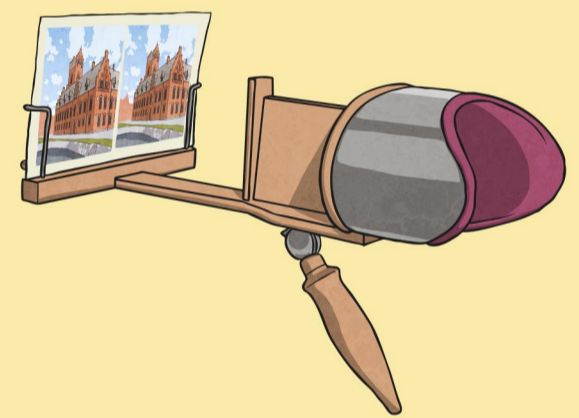

stereoscope

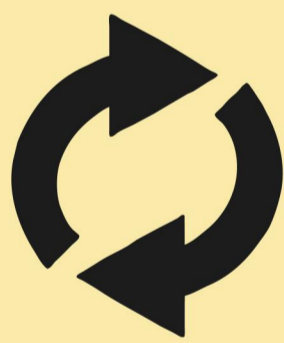

loop



still image

Animation Analysis	
Are the backgrounds colourful?	<input checked="" type="checkbox"/>
Do the drawings look like they're moving?	<input checked="" type="checkbox"/>
Does it have 5 frames per second?	<input checked="" type="checkbox"/>
Would it look better in stop motion?	<input type="checkbox"/>
Does the onion skinning look good?	<input checked="" type="checkbox"/>
Am I happy with the end result?	<input checked="" type="checkbox"/>
Did we work well as a team?	<input checked="" type="checkbox"/>
Did I enjoy making my animation?	<input checked="" type="checkbox"/>

analyse



evaluate



stop motion

Animation

e h e s r e c o r d a o
a a i t q a g b s o n i
k n p o a a d a t e i f
v a i p n j p c i t m r
f l b m n u e k l a a a
i y r o a q l d l u t m
e s i t c t h r f l i e
a e o i g s e o l a o k
p d d o k g b p d v n m
o l h n r b a j s e l j
t u a f l i p b o o k e
c i m y t v c u p o o l

animate

frame

loop

record

still

flip book

animation

stop motion

play

backdrop

analyse

evaluate

Animation

a n i m a t e a l s a r
g d r o c e r h o e e d
t h a u m a t r o p e m
n b a c k d r o p o p t
p l a y e f i a t c o e
a n i m a t i o n s r a
e t a m b a o d p o t p
c r a n a l y s e e e f
f l i p b o o k i r o r
s t i l l i m a g e z t
f r a m e r a t e t f o
n e v a l u a t e s o s

animate
animation
flip book
thaumatrope
zoetrope
evaluate
stereoscope
frame
loop
frame rate
still image
record
backdrop
play
analyse

Animation

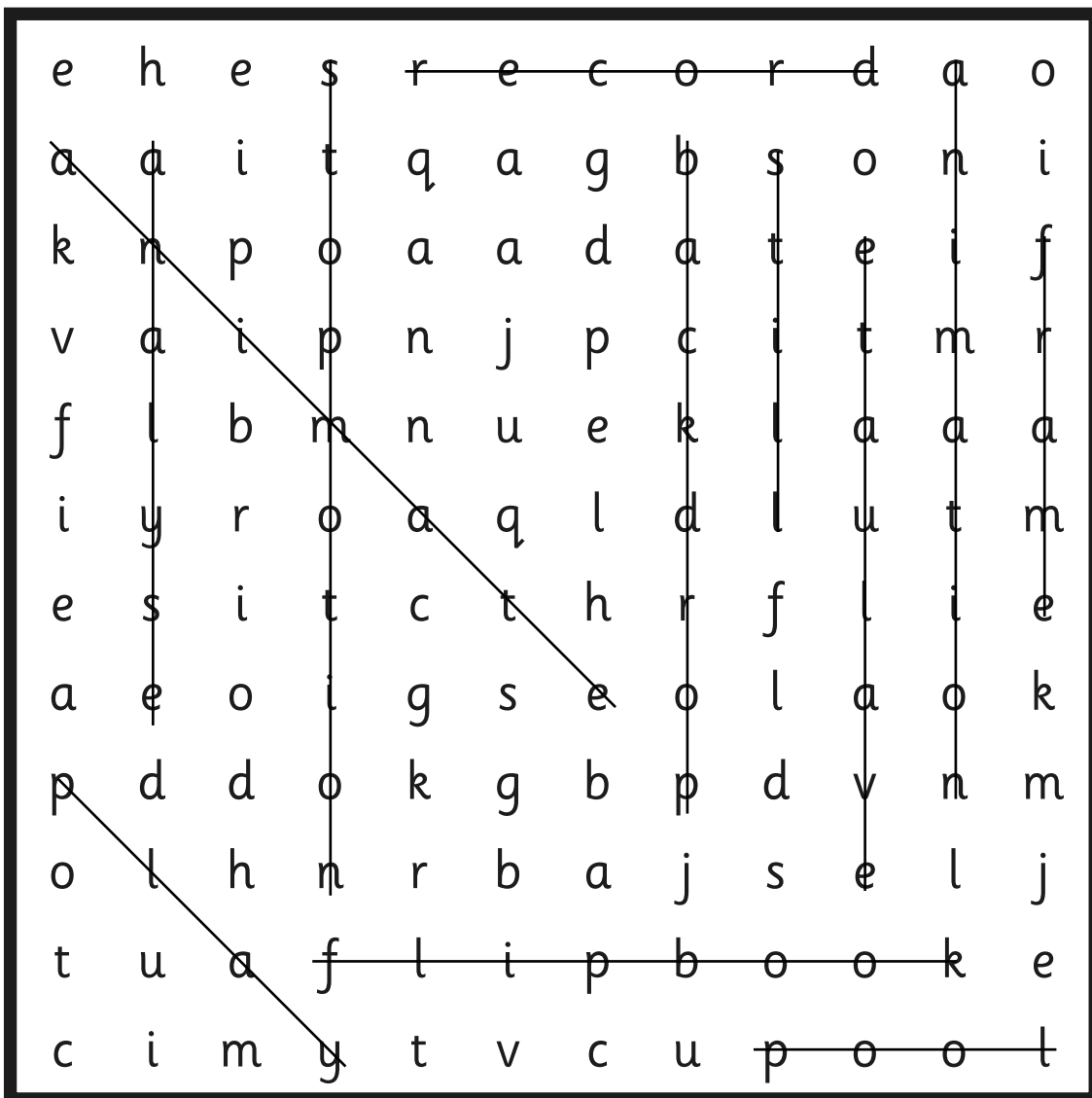

animate

frame

loop

record

still

flip book

animation

stop motion

play

backdrop

analyse

evaluate

Animation

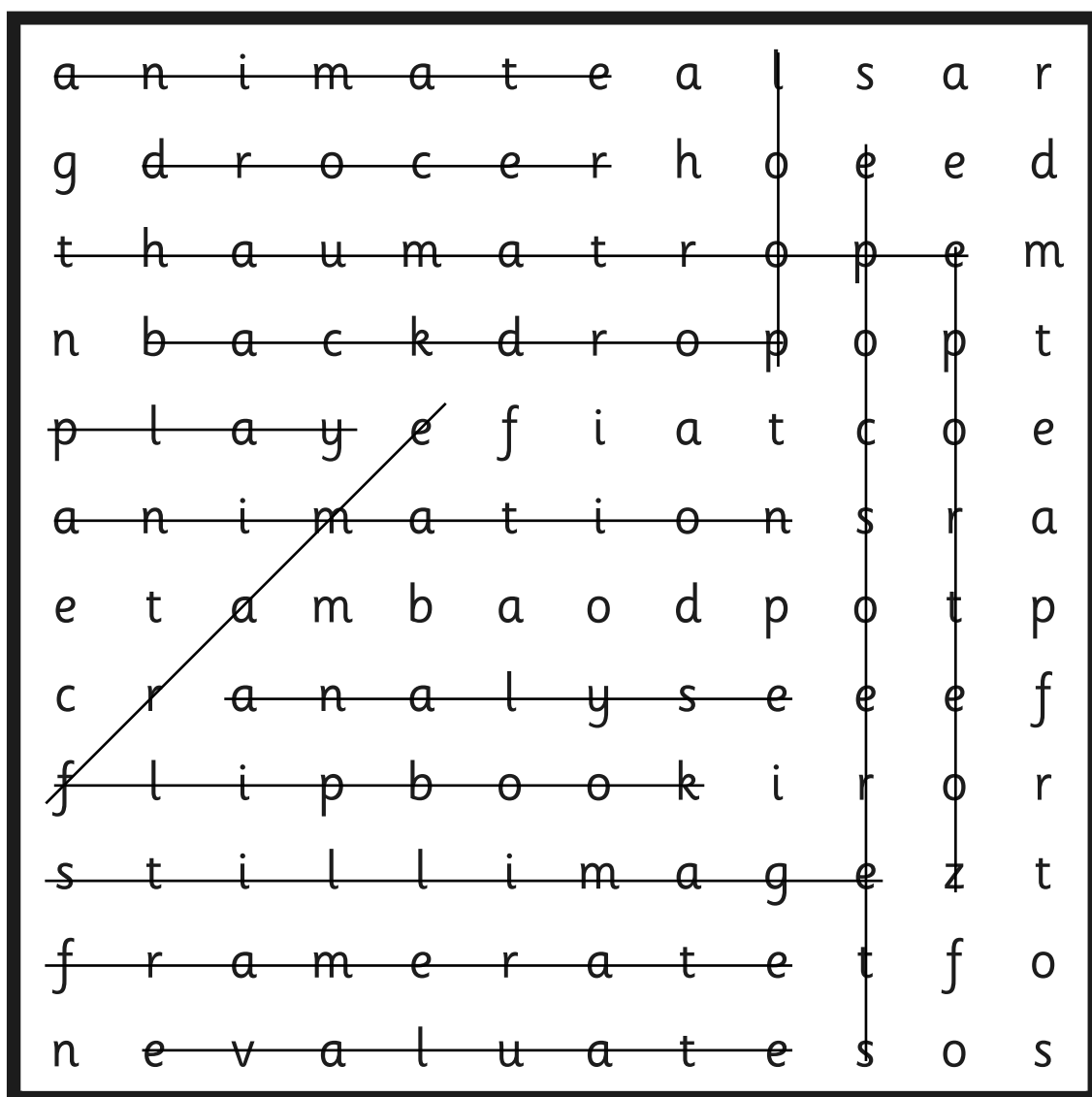

Animation

e h e s r e c o r d a o
a a i t q a g b s o n i
k n p o a a d a t e i f
v a i p n j p c i t m r
f l b m n u e k l a a a
i y r o a q l d l u t m
e s i t c t h r f l i e
a e o i g s e o l a o k
p d d o k g b p d v n m
o l h n r b a j s e l j
t u a f l i p b o o k e
c i m y t v c u p o o l

animate	animation
frame	stop motion
loop	play
record	backdrop
still	analyse
flip book	evaluate

Animation

a n i m a t e a l s a r
g d r o c e r h o e e d
t h a u m a t r o p e m
n b a c k d r o p o p t
p l a y e f i a t c o e
a n i m a t i o n s r a
e t a m b a o d p o t p
c r a n a l y s e e e f
f l i p b o o k i r o r
s t i l l i m a g e z t
f r a m e r a t e t f o
n e v a l u a t e s o s

animate
animation
flip book
thaumatrope
zoetrope
evaluate
stereoscope
frame

loop
frame rate
still image
record
backdrop
play
analyse

Animation

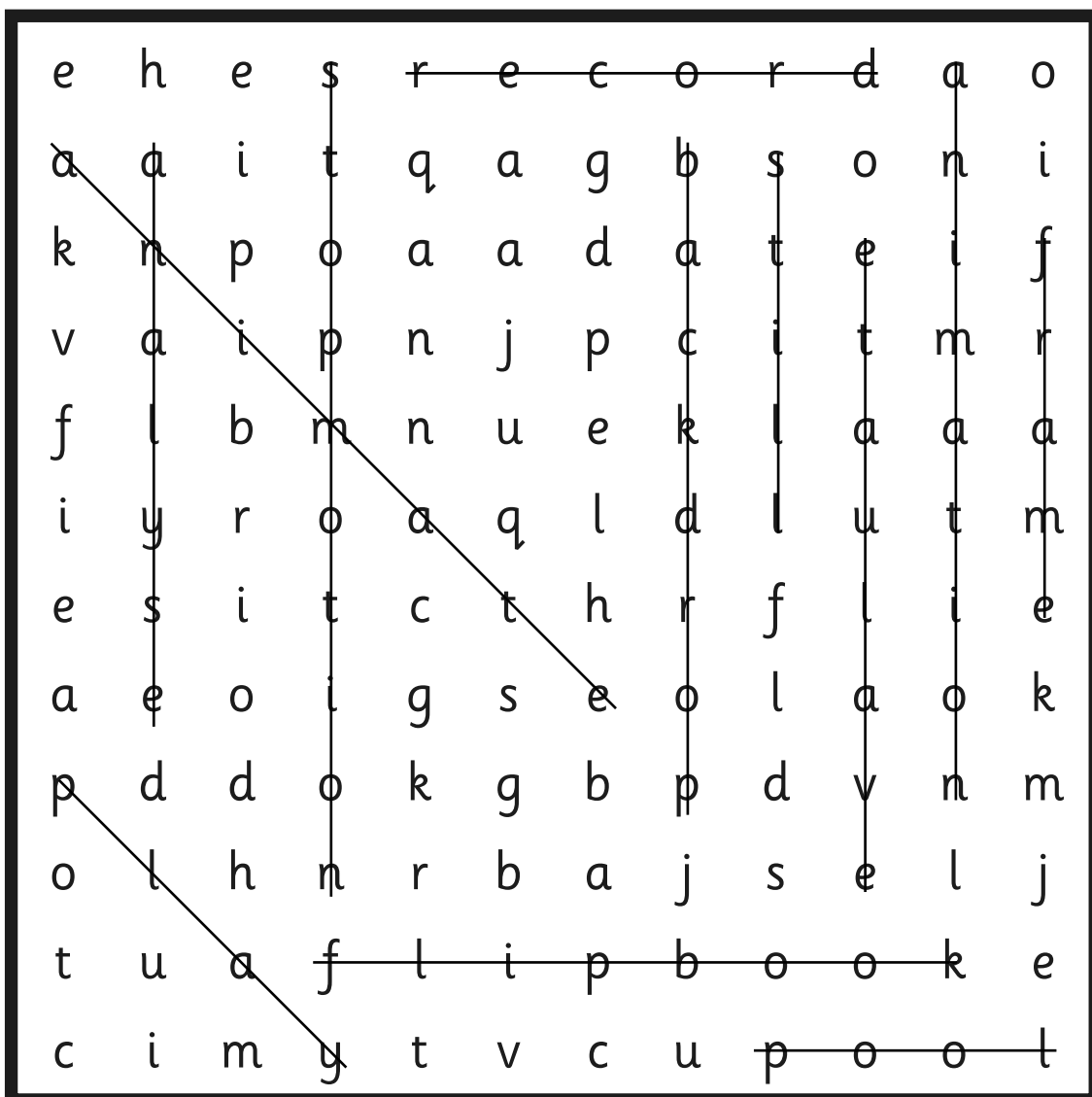

animate

frame

loop

record

still

flip book

animation

stop motion

play

backdrop

analyse

evaluate

Animation

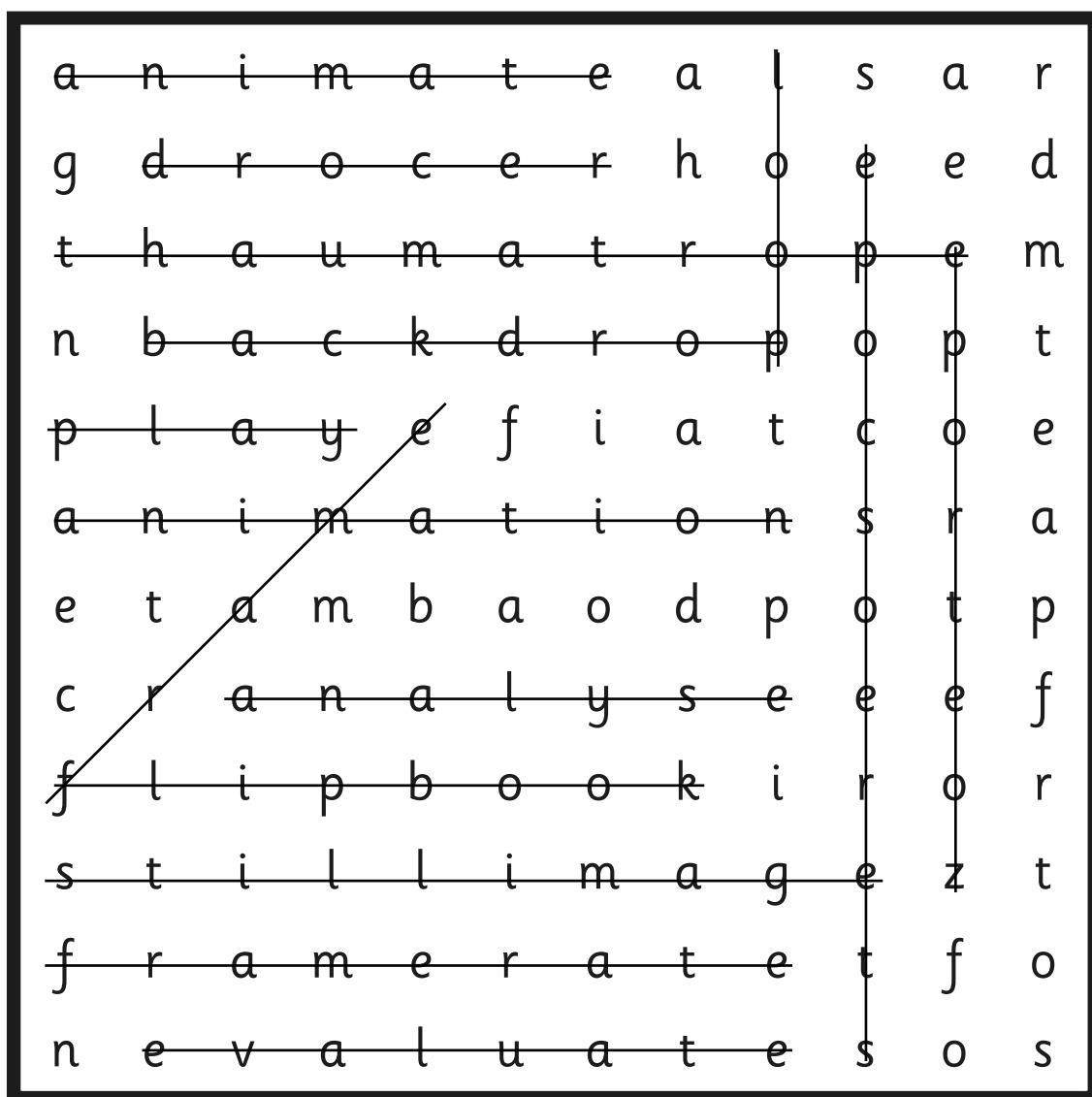

animate
animation
flip book
thaumatrope
zoetrope
evaluate
stereoscope
frame

loop
frame rate
still image
record
backdrop
play
analyse

Insert text here

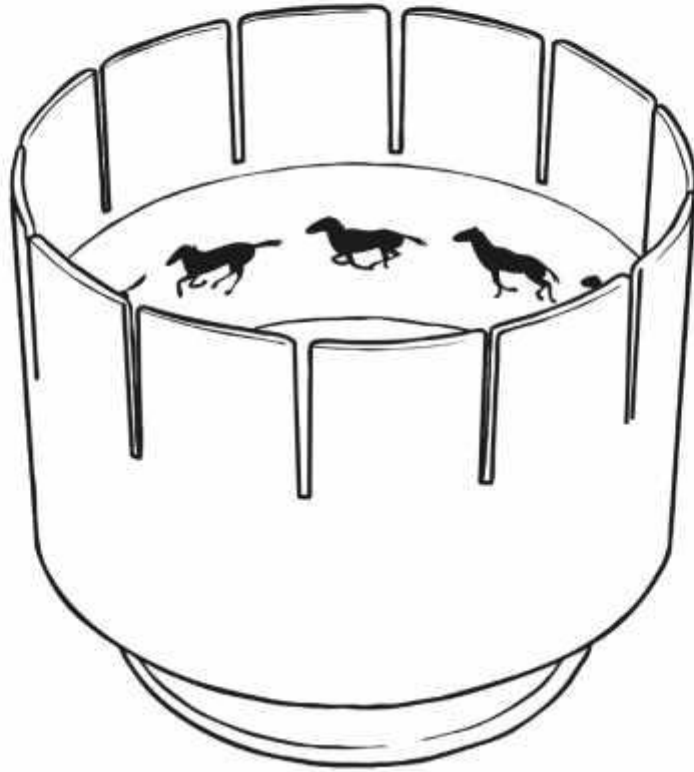

Insert text here

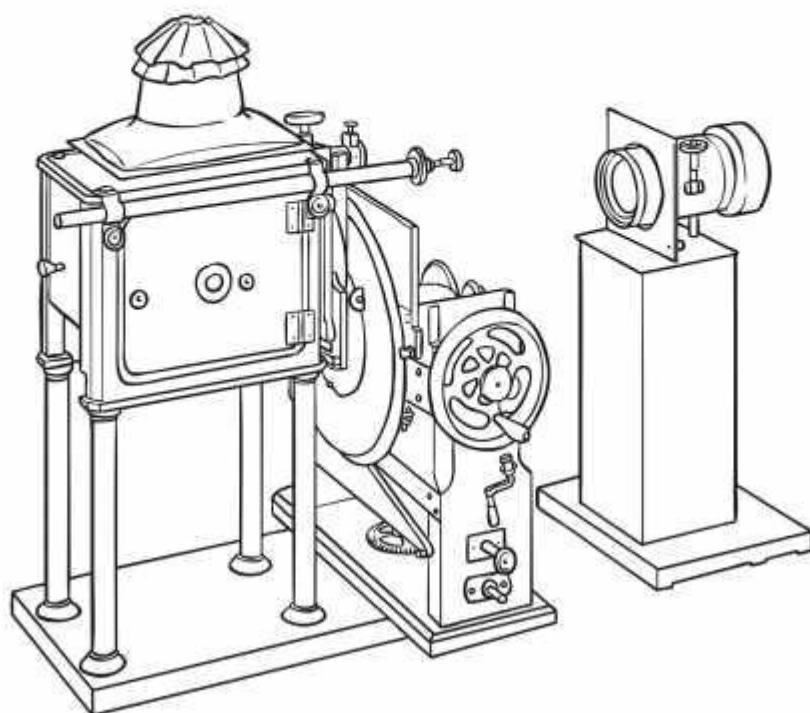

Insert text here

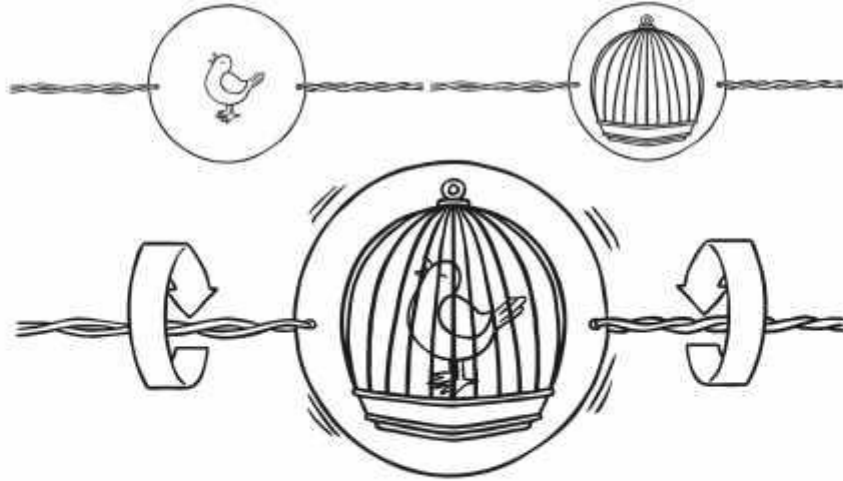

Insert text here

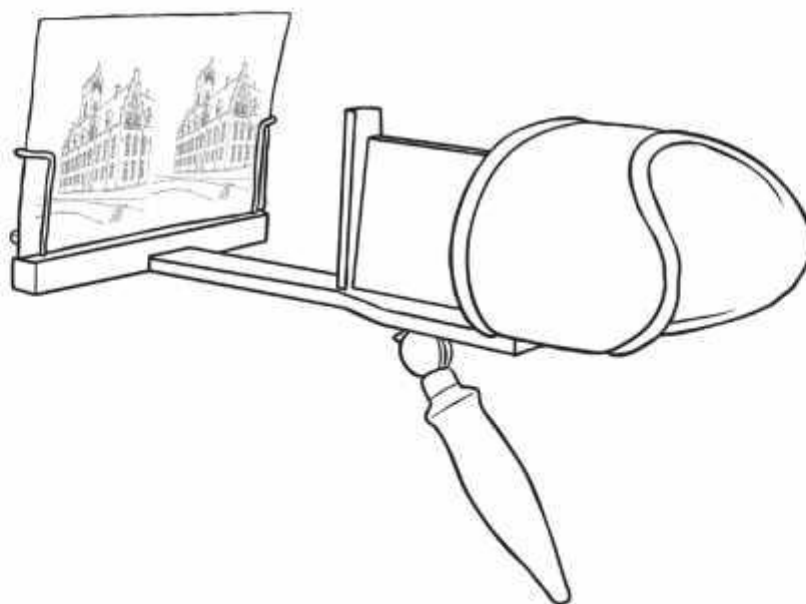

Insert text here



Insert text here



Insert text here



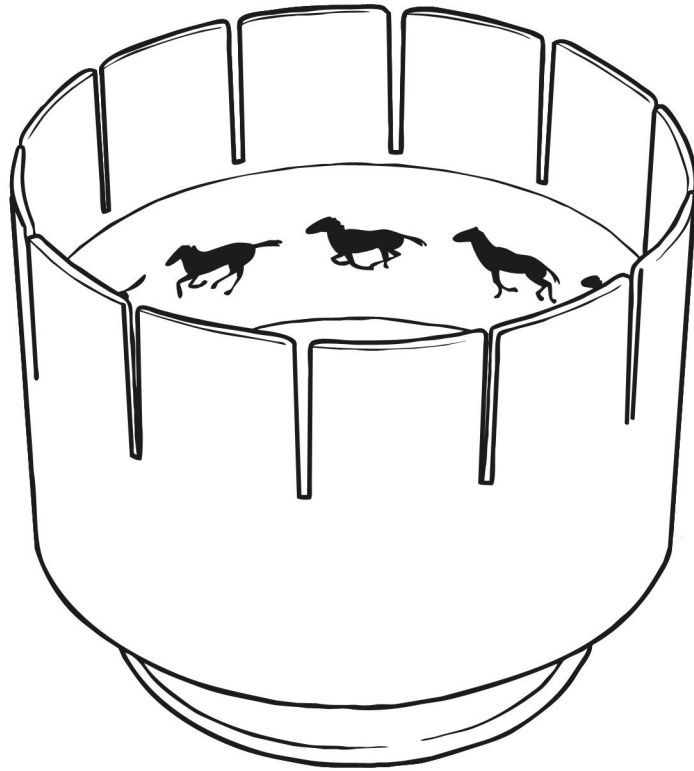

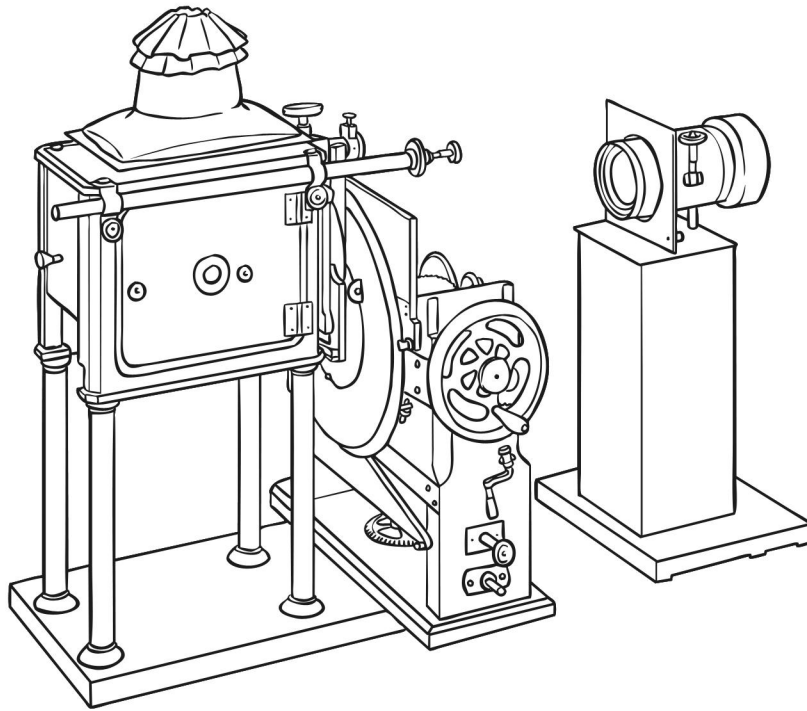

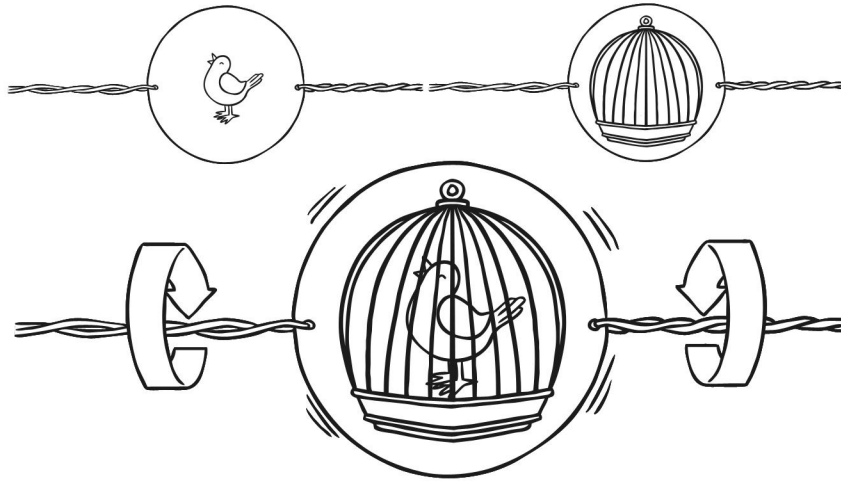

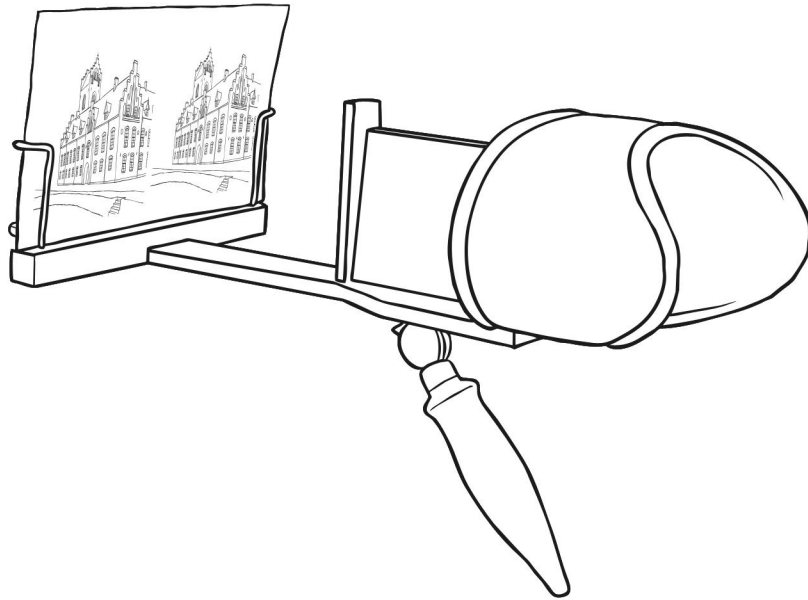





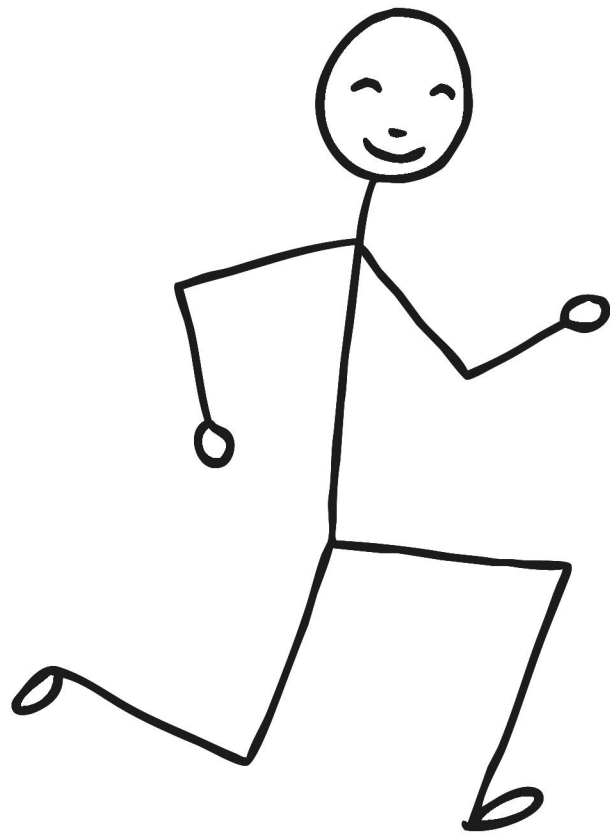



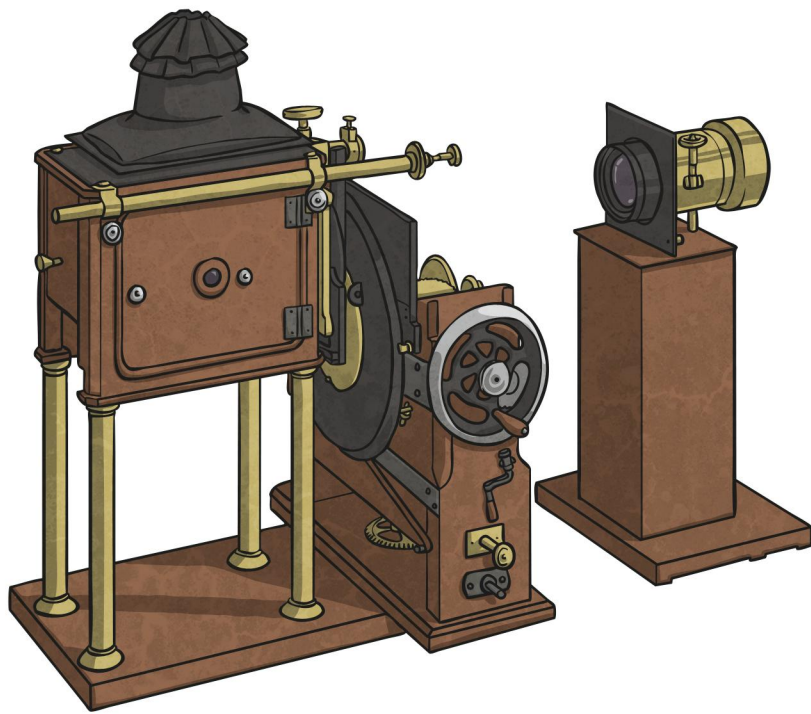

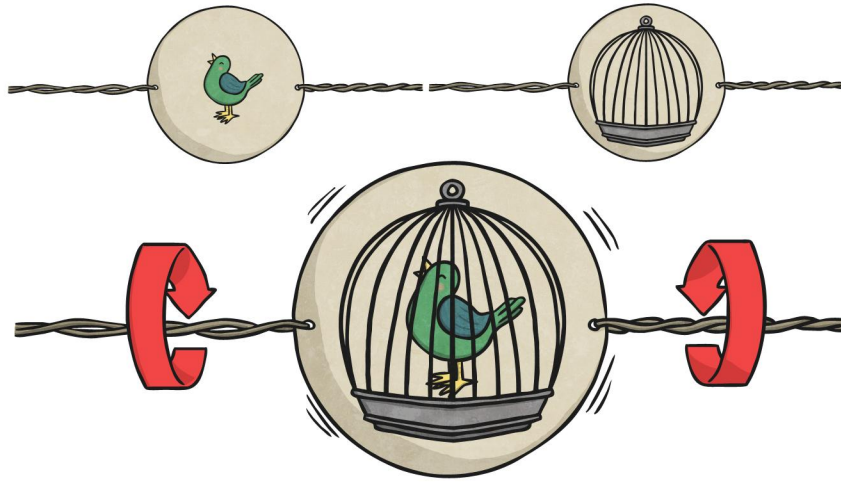

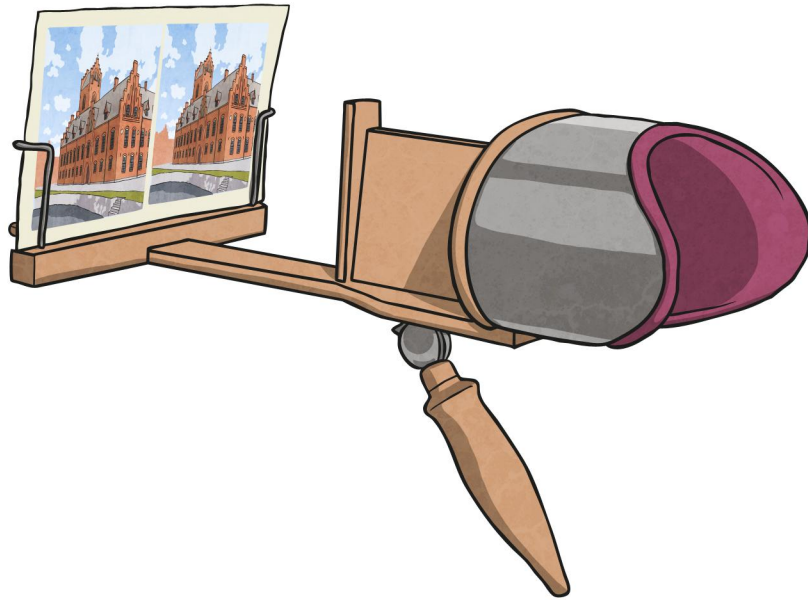







Insert text here



Insert text here

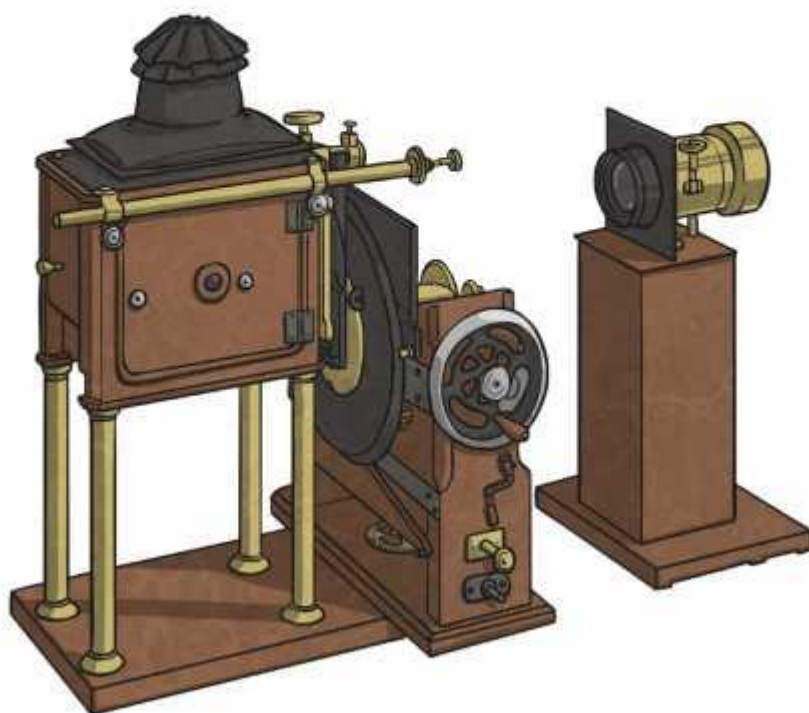

Insert text here

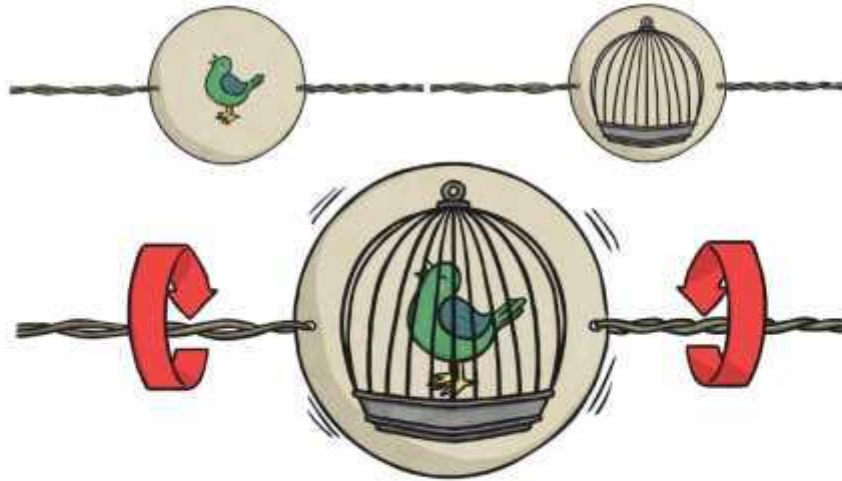

Insert text here

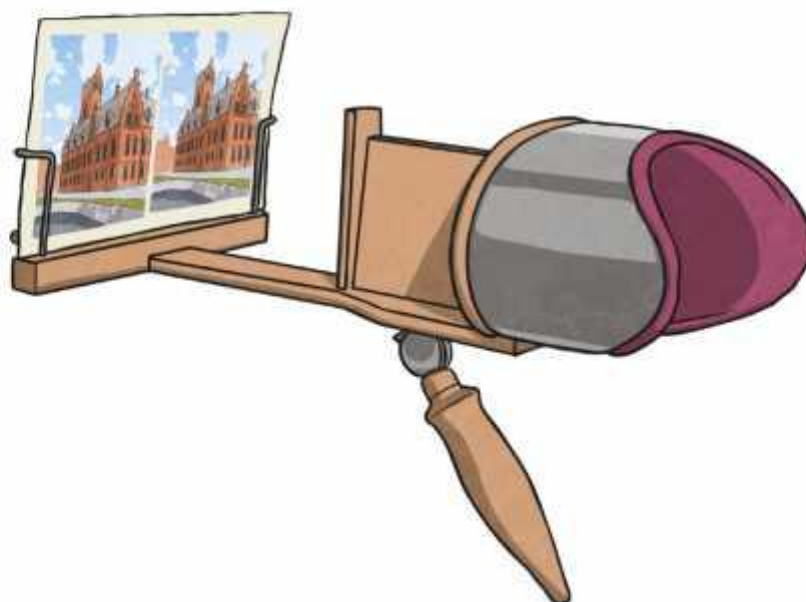

Insert text here



Insert text here



Insert text here



